

Eye

Scissors	812 - 828
Micro Needle Holders	829 - 831
Forceps	832 - 844
Specula	845 - 847
Hooks and Retractors	847 - 849
Hooks / Retractors / Manipulators	850 - 861
Fixation Rings and Markers	862 - 864
Probes and Dilators	865 - 866
Lacrimal Intubation Sets	867 - 868
Cannulas	869 - 875
Miscellaneous	876 - 877

Eye Scissors



BC190R, MA471R-MA474R, MB605R



MB605R



BC190R

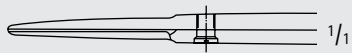

MA473R

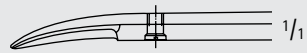

MA472R

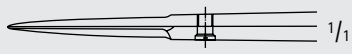

MA471R

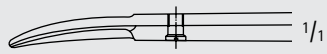

MA474R

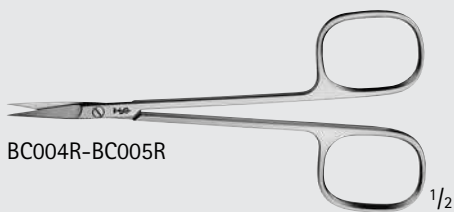

BC004R-BC005R

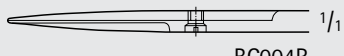

BC004R

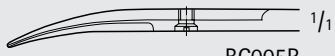

BC005R

Iris Scissors

Catalog Number	Tip	Blade	Handle	Length (in.)
MB605R	S/S	STR	RIBBON	4
MA471R	S/S	STR	RIBBON	4 1/4
MA473R	B/B	STR	RIBBON	4 1/4
BC190R	S/S	CVD	RIBBON	4
MA472R	S/S	CVD	RIBBON	4 1/4
MA474R	B/B	CVD	RIBBON	4 1/4
BC004R	S/S	STR	SQUARE	4 1/2
BC005R	S/S	CVD	SQUARE	4 1/2

EYE

Iris Scissors (continued)

Catalog Number	Tip	Blade	Handle	Length (in.)
BC100R	S/S	STR	ROUND	3 1/2
BC056R	S/S	STR	ROUND	3 3/4
BC060R	S/S	STR	ROUND	4 1/8
BC110R	S/S	STR	ROUND	4 1/4
BC112R	S/B	STR	ROUND	4 1/4
BC106R	S/S	STR	ROUND	4 1/2
BC064R	S/S	STR	ROUND	4 3/4
BC101R	S/S	CVD	ROUND	3 1/2
BC057R	S/S	CVD	ROUND	3 3/4
BC061R	S/S	CVD	ROUND	4 1/8
BC111R	S/S	CVD	ROUND	4 1/4
BC113R	S/B	CVD	ROUND	4 1/4
BC107R	S/S	CVD	ROUND	4 1/2
BC065R	S/S	CVD	ROUND	4 3/4
BC117R	S/S	LAT-ANG	ROUND	4 1/4
BC050R	S/S	STR	ROUND, CENTERED	4 1/4



BC056R-BC113R

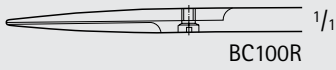

BC100R

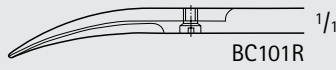

BC101R

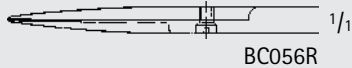

BC056R

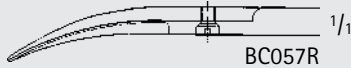

BC057R

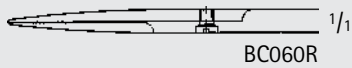

BC060R

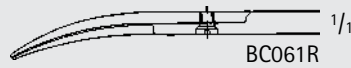

BC061R

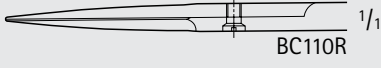

BC110R

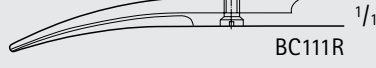

BC111R

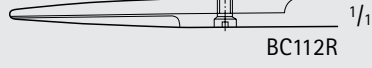

BC112R



BC113R

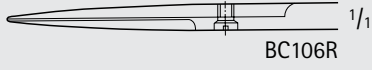

BC106R

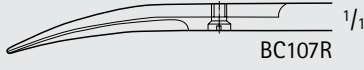

BC107R

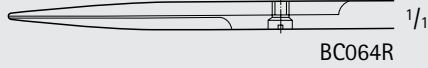

BC064R

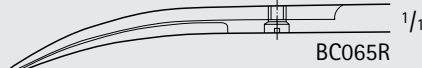

BC065R

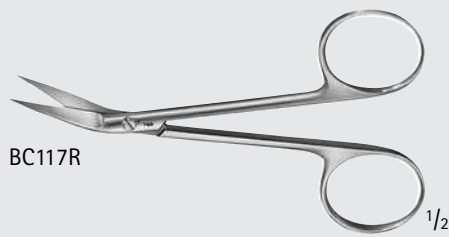

BC117R



BC117R



BC117R

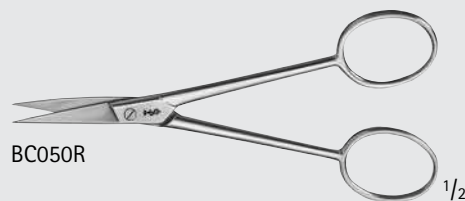

BC050R

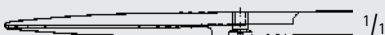

BC050R



EYE

INCHES

Eye Scissors

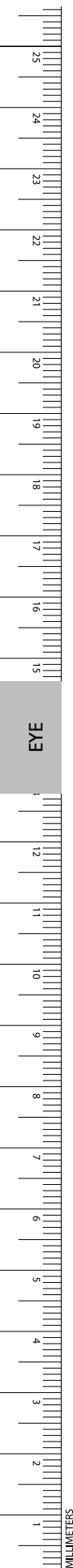

MA468R-MA470R

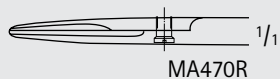

MA470R

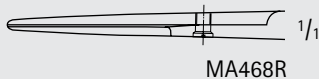

MA468R

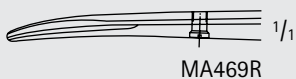

MA469R

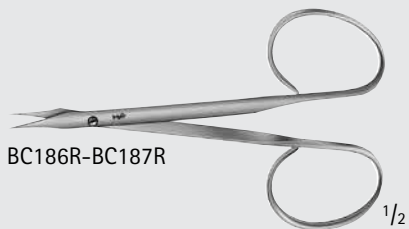

BC186R-BC187R

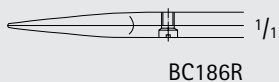

BC186R

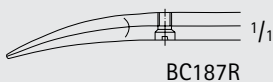

BC187R

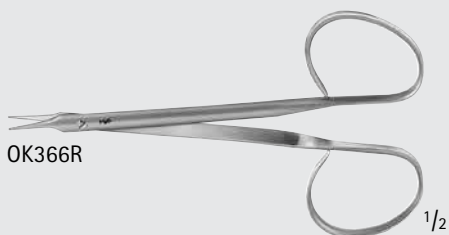

OK366R

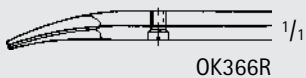

OK366R

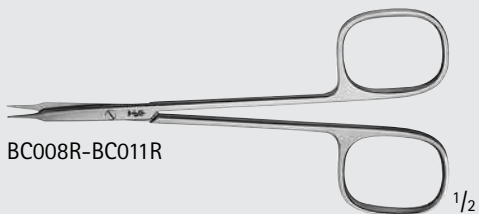

BC008R-BC011R

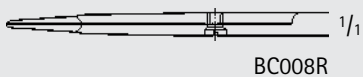

BC008R

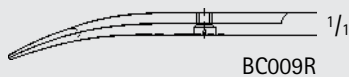

BC009R

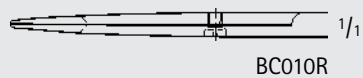

BC010R

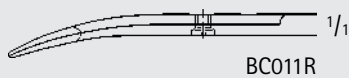

BC011R

STEVENS Tenotomy Scissors

Catalog Number	Tip	Blade	Handle	Length (in.)
BC186R	S/S	STR	RIBBON	4
MA470R	B/B	STR	RIBBON	3 3/4
MA468R	B/B	STR	RIBBON	3 7/8
MA469R	B/B	CVD	RIBBON	3 3/4
BC187R	S/S	CVD	RIBBON	4
OK366R	B/B	CVD	RIBBON	4 1/4
BC008R	S/S	STR	SQUARE	4 1/2
BC010R	B/B	STR	SQUARE	4 1/2
BC009R	S/S	CVD	SQUARE	4 1/2
BC011R	B/B	CVD	SQUARE	4 1/2



**STEVENS Tenotomy Scissors
(continued)**

Catalog Number	Tip	Blade	Handle	Length (in.)
BC170R	S/S	STR	ROUND	4 1/4
BC172R	B/B	STR	ROUND	4 1/4
BC194R	B/B	STR	ROUND	5
MA467R	B/B	STR	ROUND	5 3/4
BC171R	S/S	CVD	ROUND	4 1/4
BC173R	B/B	CVD	ROUND	4 1/4
BC195R	B/B	CVD	ROUND	5
MA466R	B/B	CVD	ROUND	5 3/4

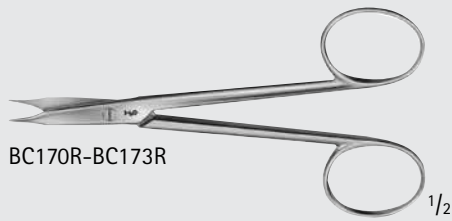

BC170R-BC173R

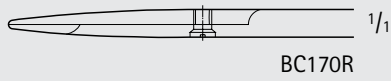

BC170R

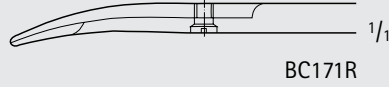

BC171R

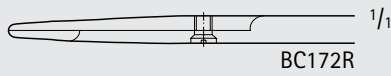

BC172R



BC173R



BC194R-BC195R

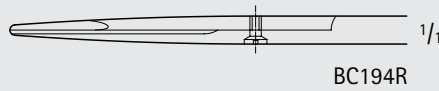

BC194R

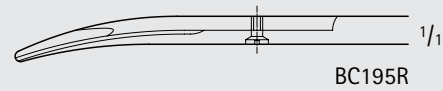

BC195R

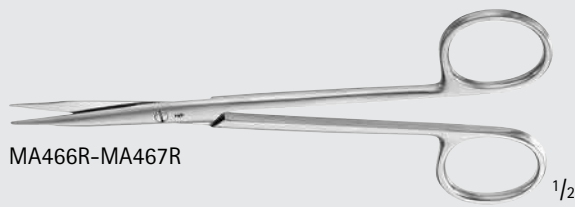

MA466R-MA467R

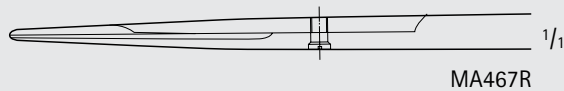

MA467R

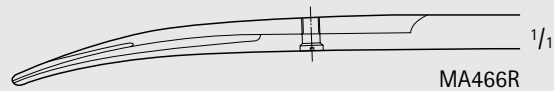

MA466R

JAMESON-WERBER Tenotomy Scissors

Catalog Number	Tip	Blade	Length (in.)
BC175R	B/B	DEL, CVD	5 1/8

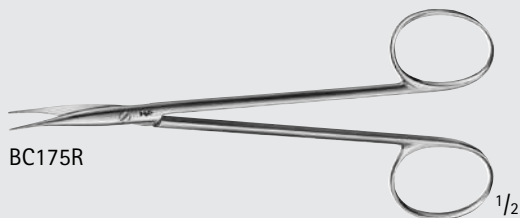

BC175R

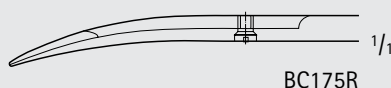

BC175R

Eye Scissors



Strabismus Scissors, Delicate

Catalog Number	Tip	Blade	Handle	Length (in.)
MA610R	B/B	CVD	RIBBON	4 1/4
BC020R	B/B	STR	SQUARE	4 1/2
BC021R	B/B	CVD	SQUARE	4 1/2
BC164R	B/B	STR	ROUND	4 1/2
BC165R	B/B	CVD	ROUND	4 1/2

KNAPP Strabismus Scissors, Delicate

Catalog Number	Tip	Blade	Length (in.)
MA462R	B/B	STR	4 3/4
MA461R	B/B	CVD	4 3/4



Enucleation Scissors

Catalog Number	Tip	Blade	Length (in.)
OC430R	B/B	SLIGHT CVD	5
US141	B/B	MEDIUM CVD	5 1/4
MA874R	B/B	FULL CVD	5 1/8

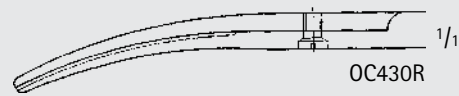
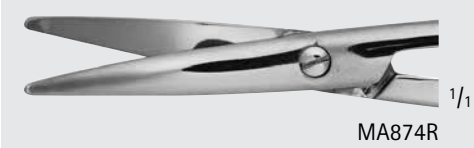

Eye Scissors

Catalog Number	Tip	Blade	Length (in.)
MA475R	PROBE	ANG	4 1/2

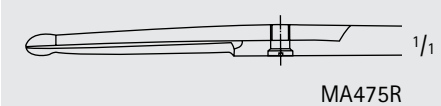
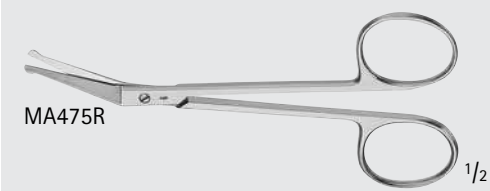

Utility Scissors, Ribbon Handle

Catalog Number	Tip	Blade	Length (in.)
MA476R	B/B	STR	4
MA477R	B/B	CVD	4
MA478R	B/B	CVD	4

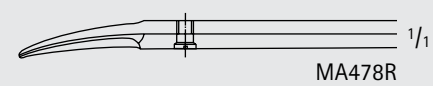
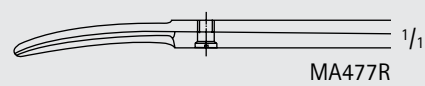
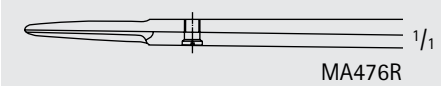
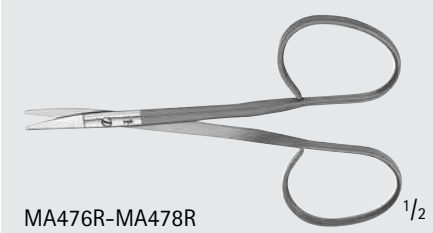

Eye Scissors





MA479R-MA480R

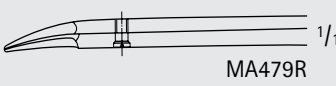

MA479R 1/1

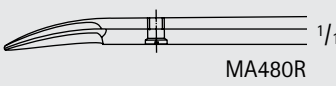

MA480R 1/1

Stitch Scissors, Ribbon Handle

Catalog Number	Tip	Blade	Length (in.)
MA479R	S/S	CVD	3 3/4
MA480R	S/S	CVD	4 3/4

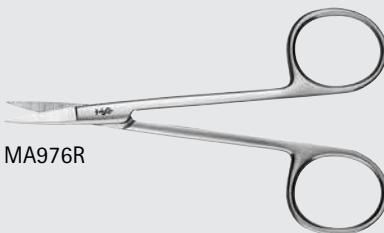

MA976R 1/2



MA976R 1/1

Stitch Scissors

Catalog Number	Tip	Blade	Length (in.)
MA976R	S/S	STR	4



MA871R 1/2



MA871R 1/1

WILMER Conjunctival Scissors

Catalog Number	Tip	Blade	Length (in.)
MA871R	S/S	ANG-FLAT	4 1/8



MA774R 1/2

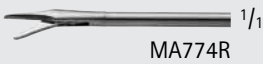

MA774R 1/1

IOL Cutter

Catalog Number	Blade	Blade Length (mm)	Diameter (mm)	Length (in.)
MA774R	SERR	6	2	4 1/2

DUROTIP Tungsten Carbide (TC) Scissors

- Excellent cutting accuracy
- Long working life
- Gold-plated rings



BC210R-BC211R

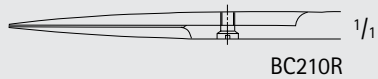

BC210R

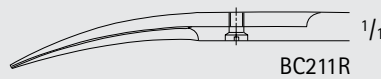

BC211R

DUROTIP TC Iris Scissors, Delicate

Catalog Number	Tip	Blade	Length (in.)
BC210R	S/S	STR	4 1/4
BC211R	S/S	CVD	4 1/4

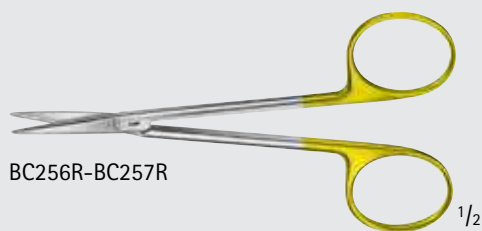

BC256R-BC257R

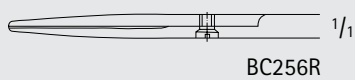

BC256R

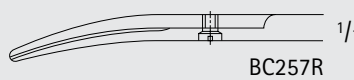

BC257R

DUROTIP TC Strabismus Scissors, Delicate

Catalog Number	Tip	Blade	Length (in.)
BC256R	B/B	STR	4 1/2
BC257R	B/B	CVD	4 1/2



Eye

DUROTIP™ Scissors



Wavecut

- Wavecut scissors have one serrated cutting edge to help prevent tissue from slipping. The W after the item number indicates the scissors are the wavecut style, e.g. BC211W.

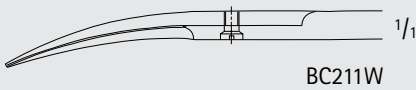

DUROTIP TC Iris Scissors, Wavecut

Catalog Number	Tip	Blade	Length (in.)
BC211W	S/S	CVD	4 1/4

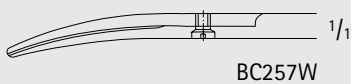

DUROTIP TC Strabismus Wavecut Scissors

Catalog Number	Tip	Blade	Length (in.)
BC257W	B/B	CVD	4 1/2

OC498R-OC500R



OC498R



OC499R



OC500R

VANNAS Micro Scissors

Catalog Number	Tip	Blade	Handle	Length (in.)
OC498R	S/S	STR	FLAT, SERR	3 1/4
OC499R	S/S	CVD	FLAT, SERR	3 1/4
OC500R	S/S	ANG	FLAT, SERR	3 1/4



FD011R-FD015R



FD014R

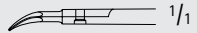

FD015R

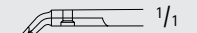

FD011R

VANNAS Micro Scissors

Catalog Number	Tip	Blade	Handle	Length (in.)
FD014R	S/S	STR	FLAT, SERR	4 3/4
FD015R	S/S	CVD	FLAT, SERR	4 3/4
FD011R	S/S	ANG	FLAT, SERR	4 3/4
FD018R	S/S	STR	FLAT, SERR	6 1/4
FD019R	S/S	CVD	FLAT, SERR	6 1/4



FD018R-FD019R

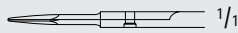

FD018R

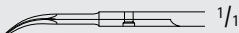

FD019R



MA865R

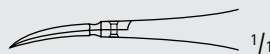

MA865R

VANNAS Micro Scissors, Wide Handle

Catalog Number	Tip	Tip Size (mm)	Blade	Handle	Length (in.)
MA865R	S/S	10	CVD	FLAT, WIDE SERR	4 3/4

Eye Scissors



VANNAS Capsulotomy Scissors

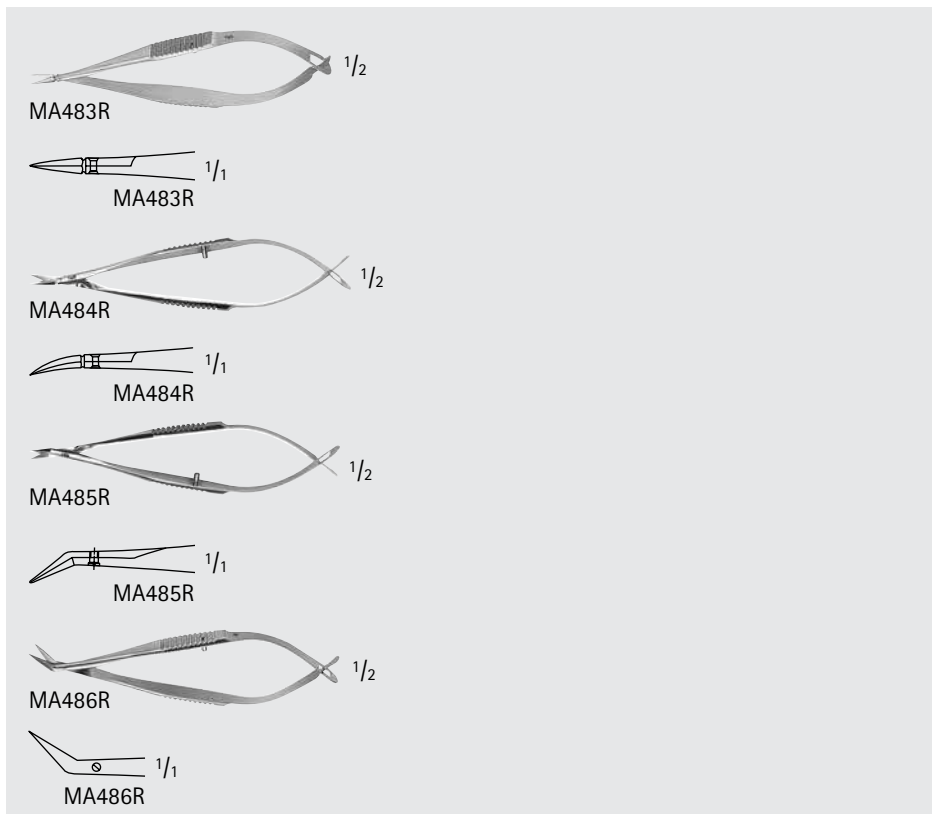

Catalog Number	Tip	Blade	Handle	Length (in.)
MA483R	S/S	STR	FLAT, SERR	3 1/4
MA484R	S/S	CVD	FLAT, SERR	3 1/4
MA485R	S/S	ANG-DOWN	FLAT, SERR	3 1/4
MA486R	S/S	ANG-UP	FLAT, SERR	3 1/4

Micro Scissors

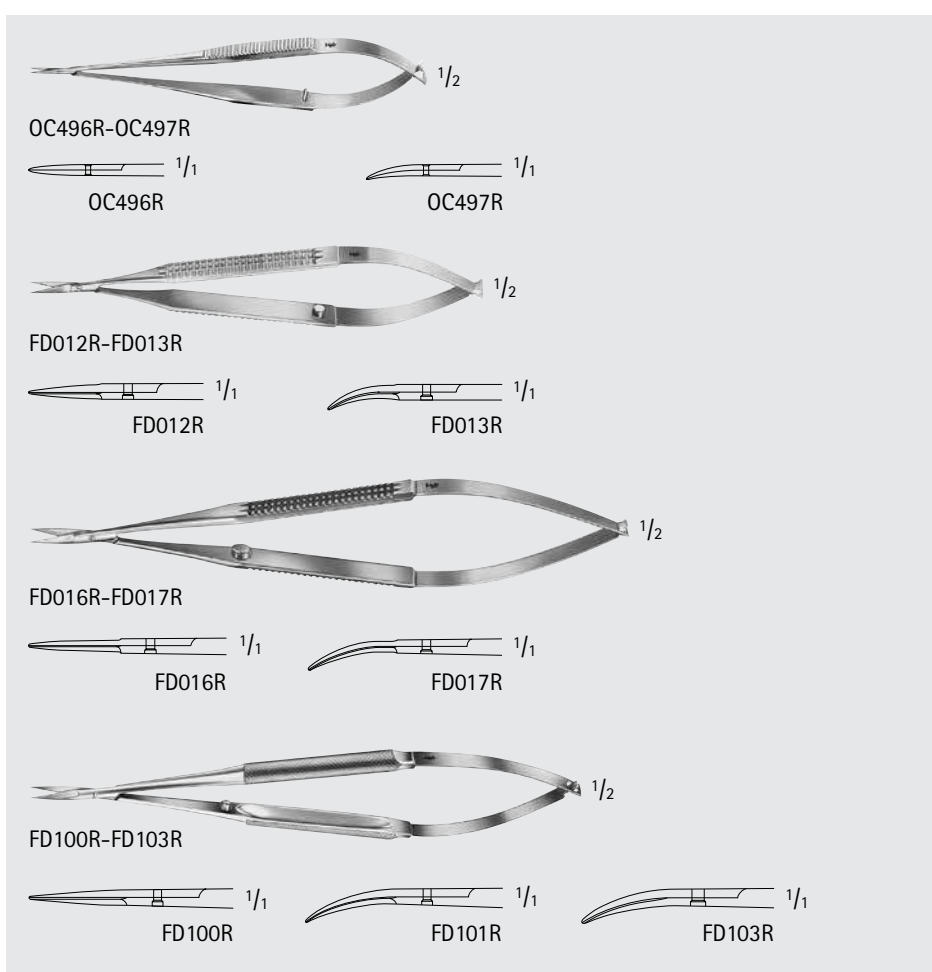

Catalog Number	Tip	Blade	Handle	Length (in.)
OC496R	S/S	STR	FLAT, SERR	4 1/8
OC497R	S/S	CVD	FLAT, SERR	4 1/8
FD012R	S/S	STR	FLAT, SERR	4 3/4
FD013R	S/S	CVD	FLAT, SERR	4 3/4
FD016R	S/S	STR	FLAT, SERR	6 1/4
FD017R	S/S	CVD	FLAT, SERR	6 1/4
FD100R	S/S	STR	ROUND	5 3/4
FD101R	S/S	CVD	ROUND	5 3/4
FD103R	B/B	CVD	ROUND	5 3/4

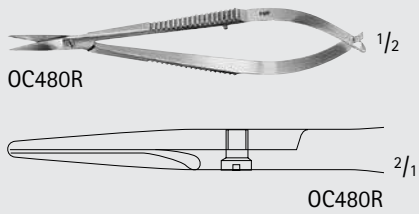

MCCLURE Micro Scissors

Catalog Number	Tip	Blade	Handle	Length (in.)
OC480R	S/S	STR	FLAT, SERR	3 3/4

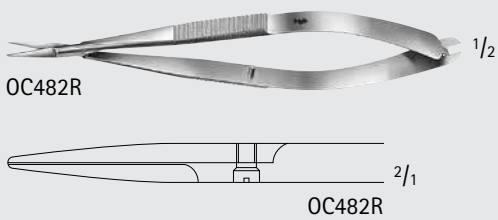

NOYES Micro Scissors

Catalog Number	Tip	Blade	Handle	Length (in.)
OC482R	S/B	STR	FLAT, SERR	5

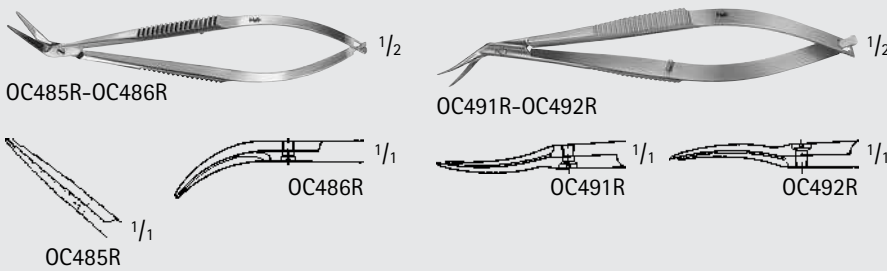

CASTROVIEJO Corneal Scissors

Catalog Number	Tip	Blade	Handle	Length (in.)
OC485R	B/B	LAT-ANG	FLAT, SERR	3 3/4
OC486R	B/B	LAT-CVD	FLAT, SERR	3 3/4
OC491R	B/B	LEFT-CVD	FLAT, SERR	4 3/8
OC492R	B/B	RIGHT-CVD	FLAT, SERR	4 3/8

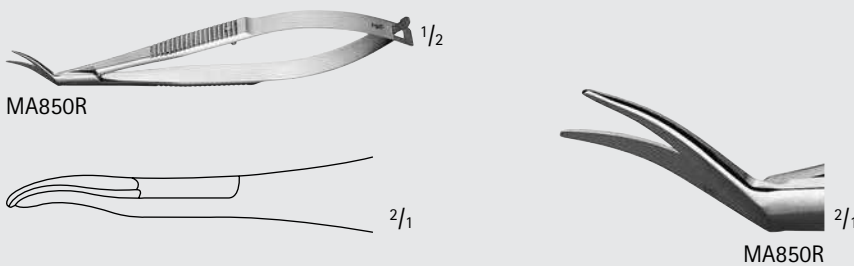

CASTROVIEJO Corneal Section Scissors

Catalog Number	Tip	Tip Size (mm)	Blade	Handle	Length (in.)
MA850R	B/B	9	CVD, ANG RIGHT	FLAT, SERR	4 1/4
MA851R	B/B	9	CVD, ANG LEFT	FLAT, SERR	4 1/4

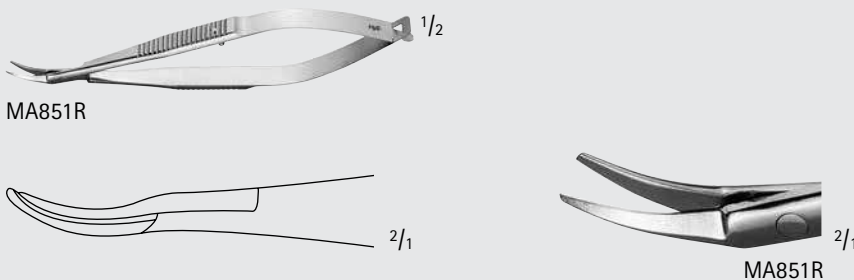

EYE

INCHES

Eye Scissors



MA858R



MA858R

CASTROVIEJO Universal Corneal Scissors

Catalog Number	Tip	Tip Size	Blade	Handle	Length (in.)
MA858R	B/B	16 MM FROM MID-SCREW	CVD	FLAT, FENESTRATED	4 3/4



MA848R

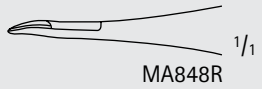

MA848R



MA849R

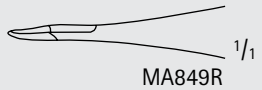

MA849R

CASTROVIEJO Corneal Scissors

Catalog Number	Tip	Tip Size	Blade	Handle	Length (in.)
MA848R	B/B	SMALL	CVD RIGHT	FLAT, WIDE SERR	4
MA849R	B/B	SMALL	CVD LEFT	FLAT, WIDE SERR	4



MA852R



MA852R



MA853R

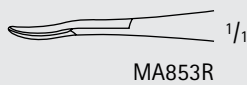

MA853R

TROUTMAN-CASTROVIEJO Corneal Scissors, W/ Catch

Catalog Number	Tip	Tip Size	Blade	Handle	Length (in.)
MA852R	B/B	MEDIUM	CVD RIGHT	FLAT, WIDE SERR	4 1/8
MA853R	B/B	MEDIUM	CVD LEFT	FLAT, WIDE SERR	4 1/8



MA854R

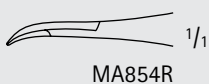

MA854R



MA855R

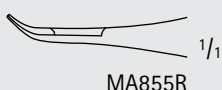

MA855R

TROUTMAN-KATZIN Corneal Scissors, W/ Catch

Catalog Number	Tip	Blade	Handle	Length (in.)
MA854R	B/B	STRONG CVD RIGHT	FLAT, WIDE SERR	4 1/8
MA855R	B/B	STRONG CVD LEFT	FLAT, WIDE SERR	4 1/8

EYE



MA847R

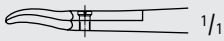

MA847R

TROUTMAN Corneal Scissors, W/ Catch

Catalog Number	Tip	Blade	Handle	Length (in.)
MA847R	B/B	CVD RIGHT	FLAT, WIDE SERR	4 1/8



MA859R

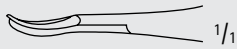

MA859R

KATZIN Corneal Transplant Scissors

Catalog Number	Tip	Tip Size	Blade	Handle	Length (in.)
MA859R	B/B	MEDIUM	CVD RIGHT	FLAT, FENESTRATED	4 1/8
MA860R	B/B	MEDIUM	CVD LEFT	FLAT, FENESTRATED	4 1/8



MA860R



MA860R



MA856R



MA856R

RICH Corneal Scissors

Catalog Number	Tip	Tip Size	Blade	Handle	Length (in.)
MA856R	S/S	X-DEL	CVD RIGHT	FLAT, WIDE SERR	4 1/8
MA857R	S/S	X-DEL	CVD LEFT	FLAT, WIDE SERR	4 1/8



MA857R

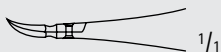

MA857R



MA873R



MA873R

Micro Iris Scissors

Catalog Number	Tip	Tip Size	Blade	Handle	Length (in.)
MA873R	S/S	10 MM FROM MID-SCREW	CVD	FLAT, SERR	4 1/8

Eye Scissors

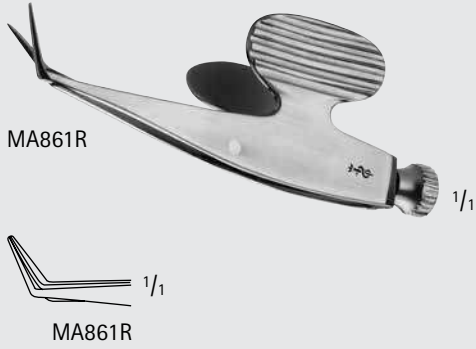

BARRAQUER Iris Scissors

Catalog Number	Tip	Tip Size (mm)	Blade	Length (in.)
MA861R	B/B	8	ANG	2 1/4



JAFFE Stitch Scissors

Catalog Number	Tip	Blade	Handle	Length (in.)
MA862R	X-SHARP/ X-SHARP	CVD	FLAT, WIDE SERR	4 3/4

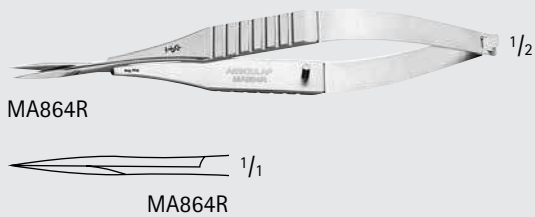

Stitch Scissors, Fine

Catalog Number	Tip	Blade	Handle	Length (in.)
MA864R	S/S	STR	FLAT, WIDE SERR	5 1/8

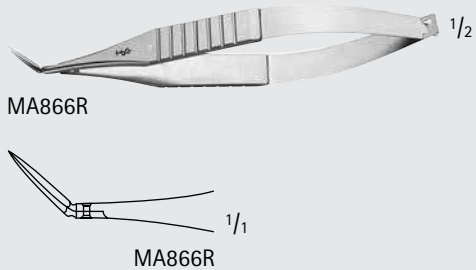

STERN-GILLS Scissors

Catalog Number	Tip	Tip Size (mm)	Blade	Handle	Length (in.)
MA866R	S/S	10	STR-ANG FORWARD	FLAT, WIDE SERR	4 1/2

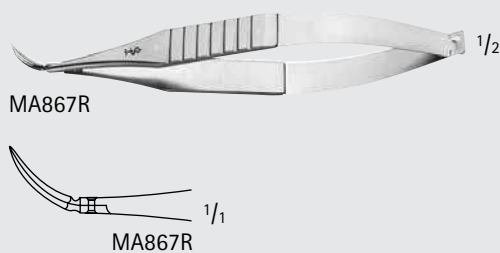

URIBE-STERN Scissors

Catalog Number	Tip	Tip Size (mm)	Blade	Handle	Length (in.)
MA867R	S/S	10	CVD-ANG FORWARD	FLAT, WIDE SERR	4 3/4





UTHOFF-GILLS Capsulotomy Scissors

Catalog Number	Tip	Tip Size (mm)	Blade	Handle	Length (in.)
MA868R	B/B	10	ANG, CVD	FLAT, WIDE SERR	4 3/4

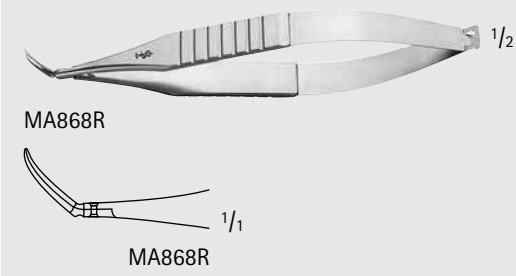

GILLS-WELSH VANNAS Scissors

Catalog Number	Tip	Tip Size (mm)	Handle	Length (in.)
MA870R	S/S	11	FLAT, WIDE SERR	3 1/4

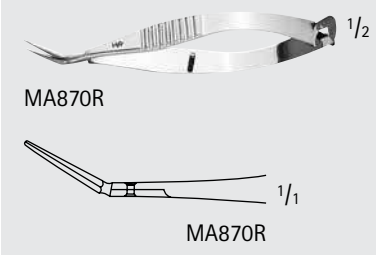

DEWECKER Iris Scissors

Catalog Number	Tip	Blade	Length (in.)
MA612R	S/B	CVD	4 1/2

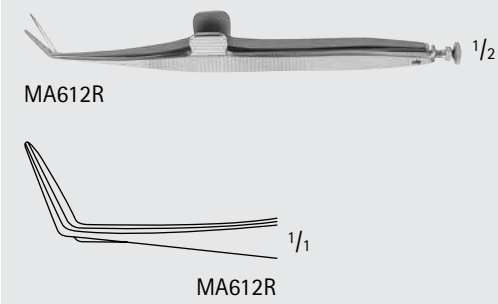

Eye Scissors

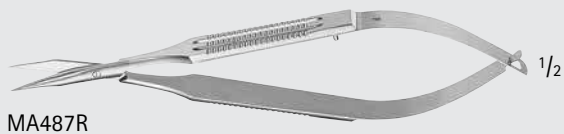

MA487R

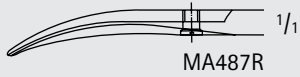

MA487R



US137-US138

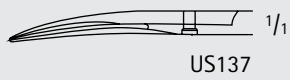

US137

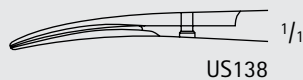

US138

WESTCOTT Stitch and Utility Scissors

Catalog Number	Tip	Blade	Handle	Length (in.)
MA487R	S/S	CVD	FLAT, SERR	5 1/2
US137	S/S	CVD	FLAT, SERR	4 1/2
US138	B/B	CVD	FLAT, SERR	4 1/2

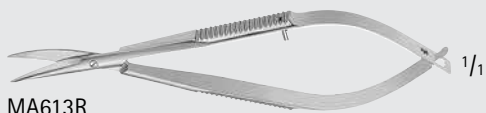

MA613R

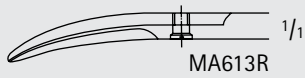

MA613R

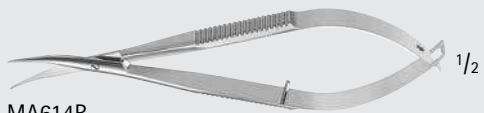

MA614R

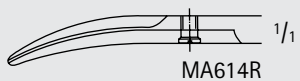

MA614R

WESTCOTT Tenotomy Scissors

Catalog Number	Tip	Blade	Handle	Length (in.)
MA613R	B/B	CVD, RIGHT HAND	FLAT, SERR	4 3/4
MA614R	B/B	CVD, LEFT HAND	FLAT, SERR	4 3/4



FD020R-FD021R

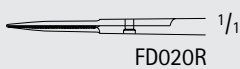

FD020R

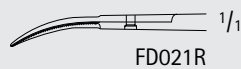

FD021R

MILLES I Micro Scissors

Catalog Number	Tip	Blade	Handle	Length (in.)
FD020R	S/S	STR, SERR	FLAT, SERR	6 1/4
FD021R	S/S	CVD, SERR	FLAT, SERR	6 1/4

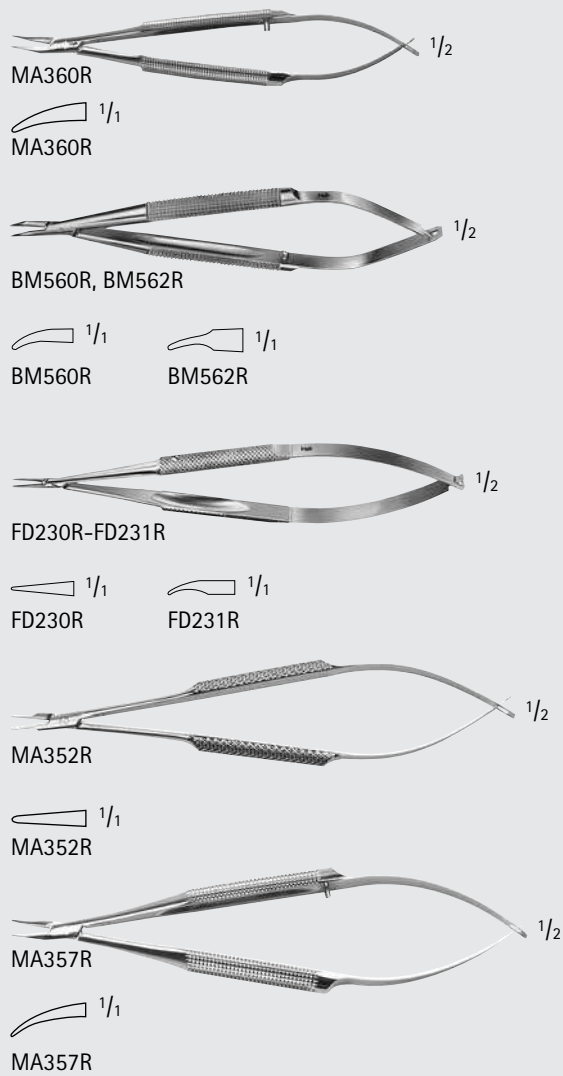

**BARRAQUER Micro Needle Holder,
Round Knurled Handle W/O Catch**

Catalog Number	Tip	Length (in.)
FD230R	STR	4 3/4
MA352R	STR	5 1/4
BM562R	CVD, DEL	4 3/4
MA360R	CVD	4 1/4
BM560R	CVD	4 1/2
FD231R	CVD	4 3/4
MA357R	CVD	5 1/4

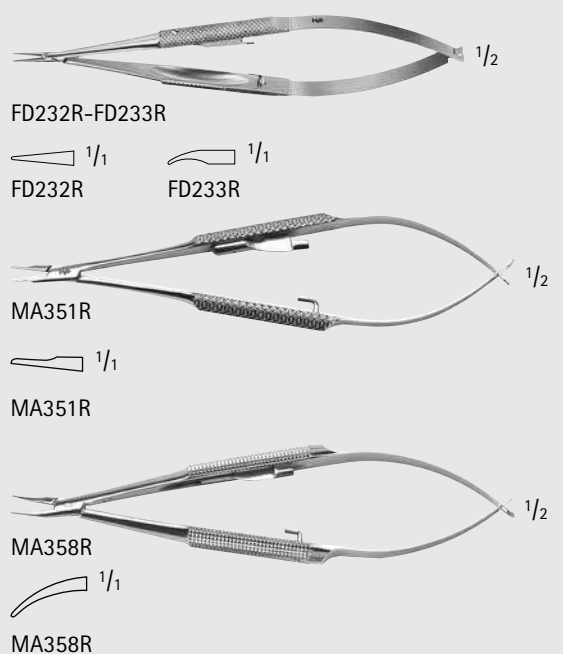

**BARRAQUER Micro Needle Holder,
Round Knurled Handle W/ Catch**

Catalog Number	Tip	Length (in.)
FD232R	STR	4 3/4
MA351R	STR	5 1/4
FD233R	CVD	4 3/4
MA358R	CVD	5 1/4



Eye

Micro Needle Holders



MA353R

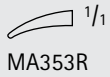

MA353R



MA354R

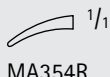

MA354R

COHEN Micro Needle Holder, Round Knurled Handle

Catalog Number	Tip	Handle	Length (in.)
MA353R	CVD	W/O CATCH	4 1/8
MA354R	CVD	W/ CATCH	4 1/8



MA355R-MA356R

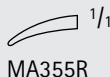

MA355R



MA356R

TROUTMAN Micro Needle Holder, Flat Handle W/ Catch

Catalog Number	Tip	Length (in.)
MA355R	CVD	4 3/4
MA356R	CVD	5 1/8



MA364R-MA366R, MA368R

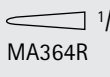

MA364R

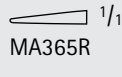

MA365R

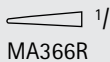

MA366R

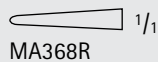

MA368R



MA363R, MA367R

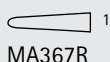

MA367R

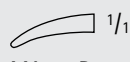

MA363R

CASTROVIEJO Micro Needle Holder, Flat Handle

Catalog Number	Tip	Jaw Length (mm)	Handle	Length (in.)
MA365R	STR	9	W/ CATCH	5 1/2
MA366R	STR	9	W/ CATCH	5 1/8
MA368R	STR	16	W/ CATCH	5 7/8
MA364R	STR	10	W/ CATCH	5 3/8
MA367R	STR	10	W/O CATCH	5 3/8
MA363R	CVD	10	W/O CATCH	5 3/8



MA628R



MA628R

Micro Needle Holder, Round Knurled Handle W/O Catch

Catalog Number	Tip	Length (in.)
MA628R	DEL, CVD	4 3/4





Micro Needle Holder, Round Knurled Handle W/ Catch

Catalog Number	Tip	Length (in.)
FD242R	STR	6
FD243R	CVD	6

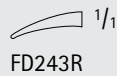
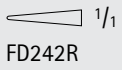

HAMPTON Micro Needle Holder, Heavy Jaw, Round Knurled Handle W/ Catch

Catalog Number	Tip	Length (in.)
MA907R	CVD	5 1/8



MCPHERSON Micro Needle Holder, Flat Handle, Delicate

Catalog Number	Tip	Handle	Length (in.)
MA908R	STR	SERR W/ CATCH	4 1/4
MA909R	STR	FENESTRATED W/O CATCH	4 1/4
MA911R	CVD	SERR W/O CATCH	4 1/8
MA910R	CVD	FENESTRATED W/ CATCH	4 1/8

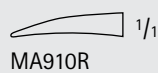
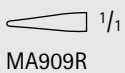
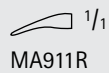
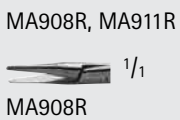

INCHES

Eye Forceps

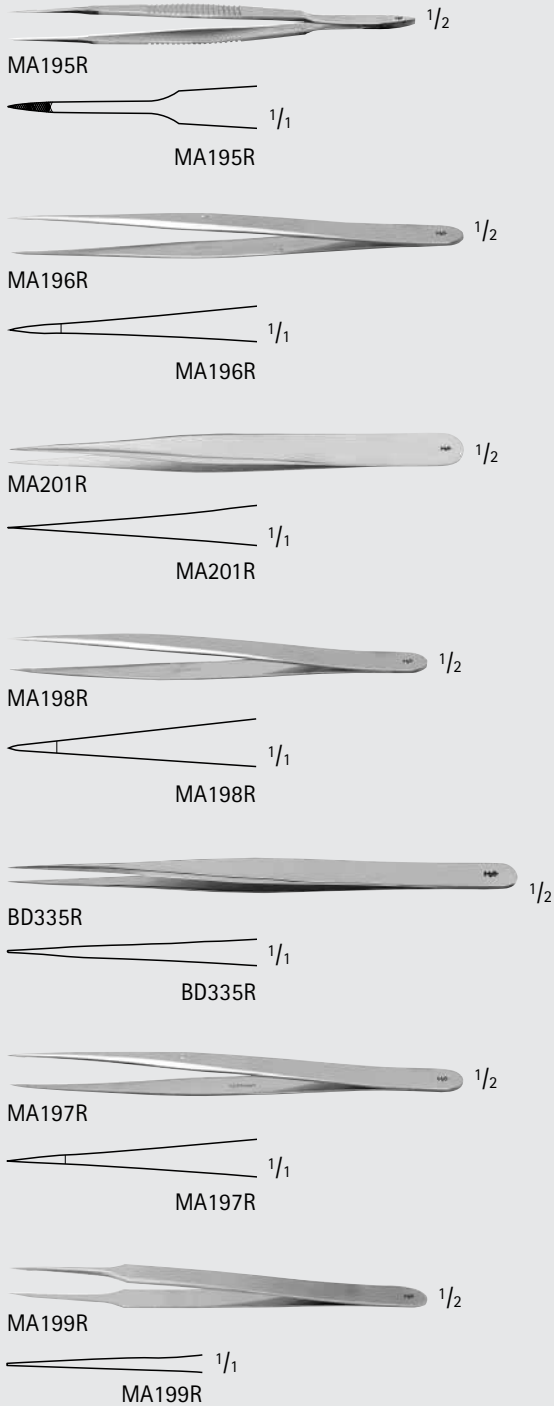

Micro Jewelers Forceps

Catalog Number	Tip	Tip Size (mm)	Tip Size (#)	Length (in.)
MA195R	STR, W/ PLATFORM, X-SERR	3	-	4 1/4
MA196R	STR, FINE, W/ PLATFORM	6	1	4 3/4
MA201R	STR, FINE	-	1	4 3/4
MA198R	STR, X-FINE, W/ PLATFORM	5	3	4 3/8
BD335R	STR	0.3	3	5 1/4
MA197R	STR, X-FINE, W/ PLATFORM	5	3	4 3/4
MA199R	STR, X-FINE, W/ PLATFORM	6	4	4 3/8
BD330R	STR	0.2	4	4 1/4
MA200R	STR, X-FINE, W/ PLATFORM	6	5	4 3/8
BD331R	STR	0.15	5	4 1/4
BD333R	CVD	0.20	5	4 1/2

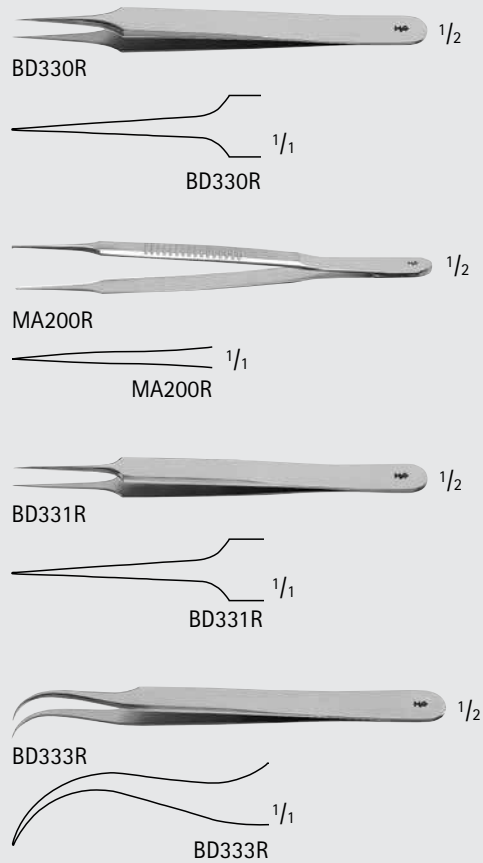



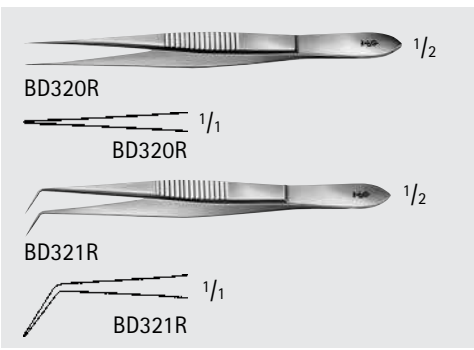

BD320R $\frac{1}{2}$
BD320R $\frac{1}{1}$

BD321R $\frac{1}{2}$
BD321R $\frac{1}{1}$

Micro Forceps

Catalog Number	Tip	Jaw	Length (in.)
BD320R	STR	SMOOTH	4
BD321R	ANG	SMOOTH	4

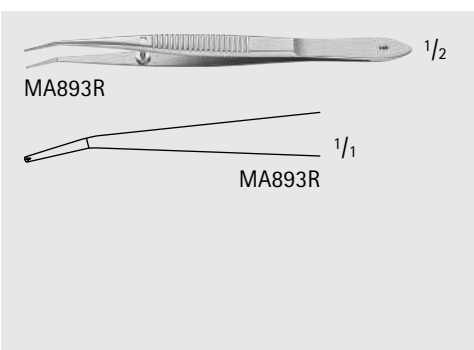

MA893R $\frac{1}{2}$
MA893R $\frac{1}{1}$

BARRAQUER Cilia Forceps

Catalog Number	Tip	Tip Size (mm)	Length (in.)
MA893R	SLIGHT-ANG	6	4 1/9

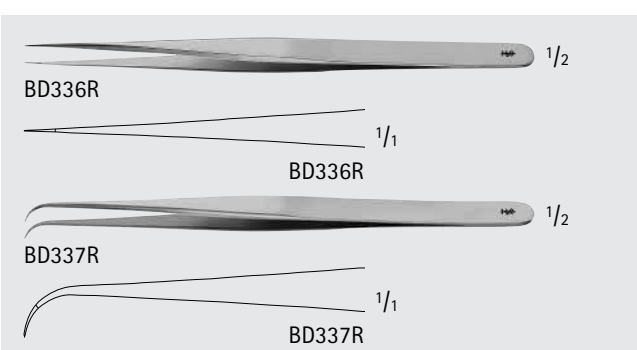

BD336R $\frac{1}{2}$
BD336R $\frac{1}{1}$

BD337R $\frac{1}{2}$
BD337R $\frac{1}{1}$

WISE Micro Suture Forceps W/ Platform

Catalog Number	Tip	Tip Size (mm)	Length (in.)
BD336R	STR	0.3	5 1/4
BD337R	CVD	0.3	5 1/4

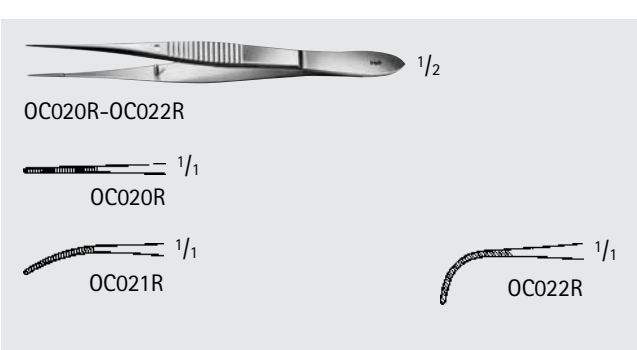

OC020R-OC022R $\frac{1}{2}$
OC020R $\frac{1}{1}$

OC021R $\frac{1}{1}$ OC022R $\frac{1}{1}$

Iris Forceps, Delicate

Catalog Number	Tip	Jaw	Length (in.)
OC020R	STR	SERR	4
OC021R	CVD	SERR	4
OC022R	HEAVY-CVD	SERR	4

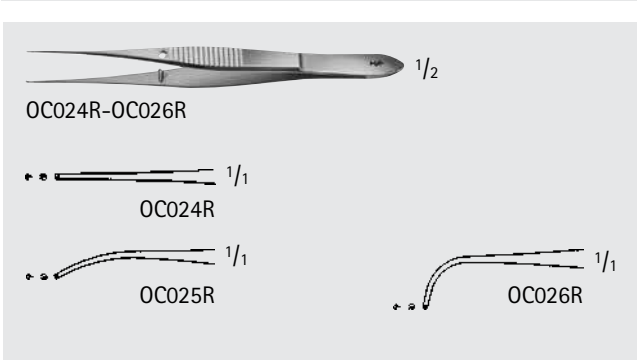

OC024R-OC026R $\frac{1}{2}$
OC024R $\frac{1}{1}$

OC025R $\frac{1}{1}$ OC026R $\frac{1}{1}$

Iris Forceps, X-Fine

Catalog Number	Tip	Teeth	Length (in.)
OC024R	STR	1 x 2	4
OC025R	CVD	1 x 2	4
OC026R	HEAVY-CVD	1 x 2	4

Eye Forceps



OC051R

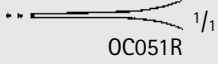

OC051R



MD580



MD580

BISHOP-HARMON Iris Forceps

Catalog Number	Teeth	Jaw	Length (in.)
OC051R	1 x 2	-	3 1/4
MD580	-	SERR	3 1/2



OC091R

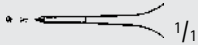

1/1

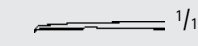

1/1

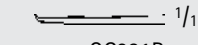

1/1

OC091R

ST. MARTIN Tissue Forceps, Delicate

Catalog Number	Teeth	Length (in.)
OC091R	1 x 2	3 1/8



OC094R

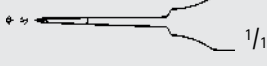

1/1

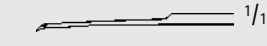

1/1

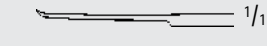

1/1

OC094R

CASTROVIEJO Tissue Forceps, Delicate

Catalog Number	Tip Size (mm)	Teeth	Length (in.)
OC094R	0.9	1 x 2	4



US133



US133

CASTROVIEJO Fixation Forceps, W/O Platform

Catalog Number	Tip Size (mm)	Teeth	Length (in.)
US133	0.5	1 x 2	4 1/4

EYE

CASTROVIEJO Suture Forceps,
W/ 1 x 2 Teeth

Catalog Number	Tip	Tip Size (mm)	Platform	Handle	Length (in.)
MB295R	STR	0.12	YES	SERR	4 1/8
MA153R	STR	0.12	YES	SERR	4 3/8
MA152R	STR	0.22	YES	SERR	4 1/4
MA158R	STR	0.3	YES	SERR	4 1/8
MB477R	STR	0.3	YES	SERR	4 3/8
MA148R	STR	0.5	YES	WIDE	4 1/4
MA150R	STR	0.5	YES	SERR	4 1/4
US136	STR	0.5	NO	WIDE W/ LOCK	4 1/4
MA151R	STR	0.9	YES	SERR	4 1/4
MA149R	STR	1.5	YES	WIDE	4 1/4
MA154R	ANG 45°	0.5	YES	SERR	4 1/4

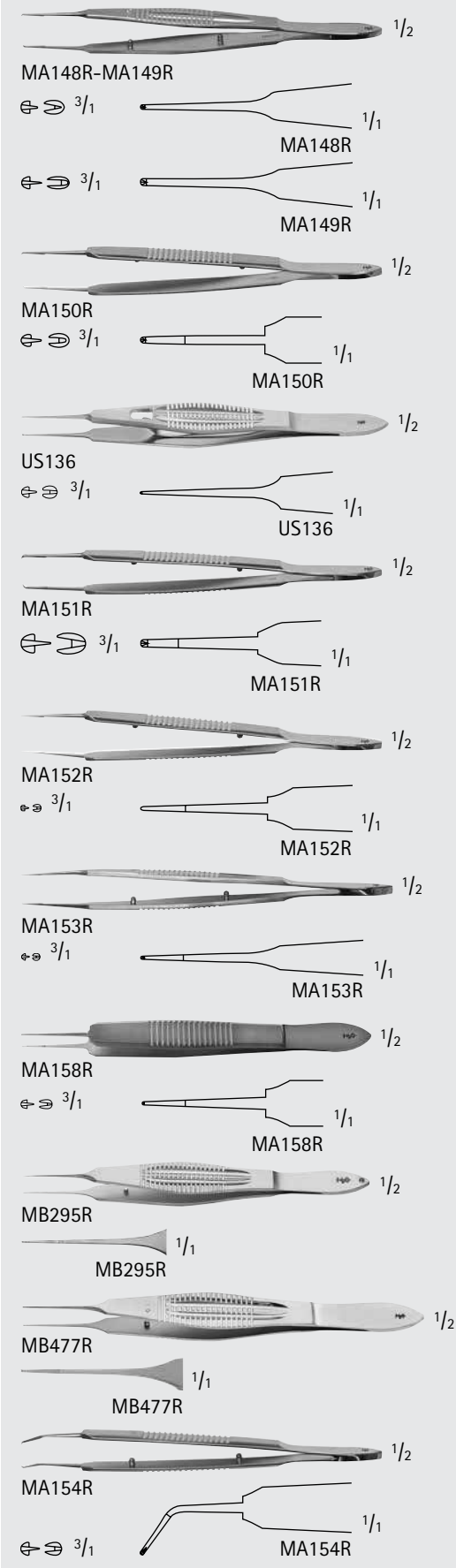

Eye Forceps



MA618R



MA618R

CASTROVIEJO Capsule Forceps, Cross-Action

Catalog Number	Tip	Length (in.)
MA618R	10 MM FROM ANGLE TO TIP	4 1/8



MB294R



MB294R

CASTROVIEJO Colibri Type Corneal Forceps

Catalog Number	Tip Size (mm)	Teeth	Length (in.)
MB294R	0.12	1 x 2	4 1/8



BD505R

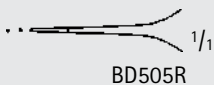

BD505R

BONN Eye Forceps, W/ Platform

Catalog Number	Tip Size (mm)	Teeth	Length (in.)
BD505R	0.2	1 x 2	3 3/4



OC100R

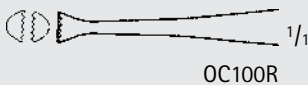

OC100R

GRAEFE Tissue Forceps

Catalog Number	Length (in.)
OC100R	4 1/4



FD280R-FD281R

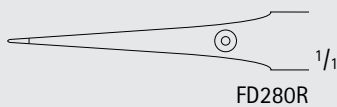

FD280R

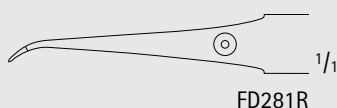

FD281R

Suture Tying Forceps, W/ Platform

Catalog Number	Tip	Tip Size (mm)	Length (in.)
FD280R	STR	0.3	4 3/4
FD281R	CVD	0.3	4 3/4



MA875R

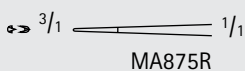

MA875R

OSHER-ELSCHNIG Forceps, W/ Platform

Catalog Number	Tip	Tip Size (mm)	Teeth	Length (in.)
MA875R	0.12	3	1 x 2	4 1/8

EYE



MA160R-MA161R

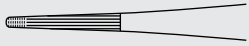

MA160R-MA161R

BONACCOLTO Utility Forceps

Catalog Number	Tip Size (mm)	Length (in.)
MA160R	1.2 x 16	4 1/4
MA161R	1.7 x 17	4 1/4



MA876R

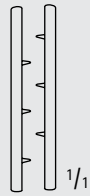
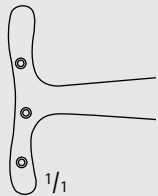

MA876R

PUTTERMAN-Type Muscle Forceps, W/ Lock

Catalog Number	Tip	Jaw	Length (in.)
MA876R	6 PINS	SERR	4



MA886R



MA886R

TENNANT Tying Forceps, W/ Platform

Catalog Number	Tip	Tip Size (mm)	Jaw	Handle	Length (in.)
MA886R	X-DEL	6	SMOOTH	ROUND	4 1/4



MA885R



MA885R

SINSKEY Tying Forceps

Catalog Number	Tip	Jaw	Handle	Length (in.)
MA885R	X-DEL	SMOOTH, CVD	FLAT, WIDE SERR	4

Eye Forceps

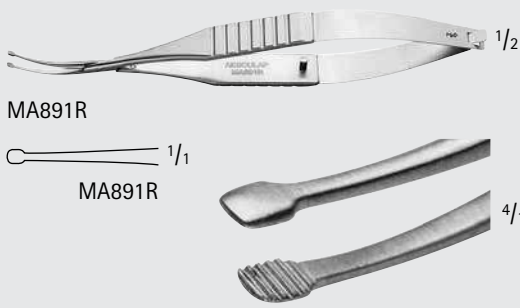

**SHEPARD Lens Holding Forceps,
Cross-Action**

Catalog Number	Tip	Jaw	Handle	Length (in.)
MA891R	DUCKBILL	CVD	FLAT, WIDE SERR	5



**CLAYMAN Lens Holding Forceps,
Cross-Action**

Catalog Number	Tip	Jaw	Handle	Length (in.)
MA892R	DEL, ANG	CVD	FLAT, WIDE SERR	4 3/4

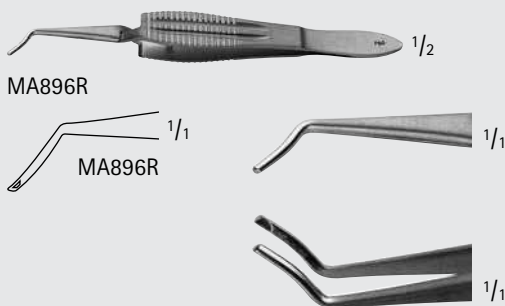

Scleral Plug Forceps, Cross-Action

Catalog Number	Tip	Tip Size (mm)	Jaw	Handle	Length (in.)
MA896R	CVD	9	ANG	FLAT, SERR	4 1/8

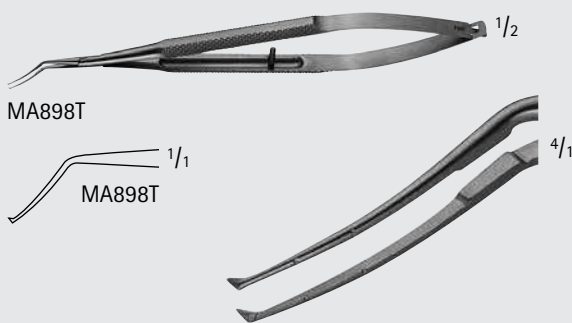

**DEVGAN Titanium Capsulorhexis
Forceps, Cross-Action**

Catalog Number	Tip	Handle	Length (in.)
MA898T	X-DEL, SEMI-SHARP	ROUND	5

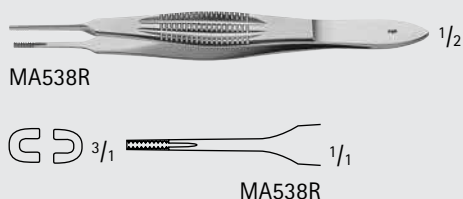

GRIFFITHS-BROWN Tissue Forceps

Catalog Number	Tip	Length (in.)
MA538R	DEL	4 1/4



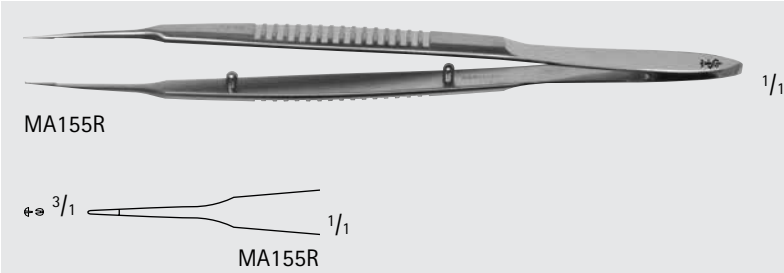

BONN Suture Forceps, W/ Platform

Catalog Number	Tip Size (mm)	Teeth	Length (in.)
MA155R	0.12	1 x 2	3 3/4

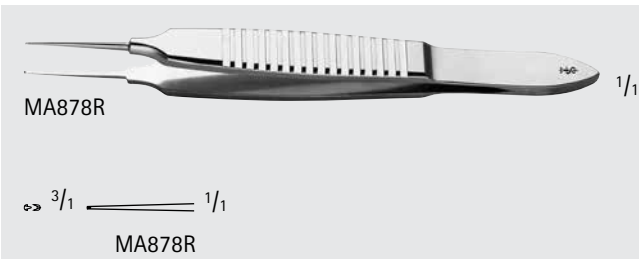

BONN Tissue Forceps

Catalog Number	Tip Size (mm)	Teeth	Length (in.)
MA878R	0.12	1 x 2	3 3/4

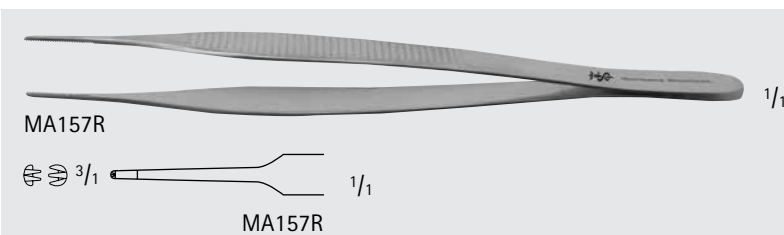

THORPE Conjunctival Fixation Forceps, W/ Platform

Catalog Number	Teeth	Length (in.)
MA157R	2 x 3	3 3/4

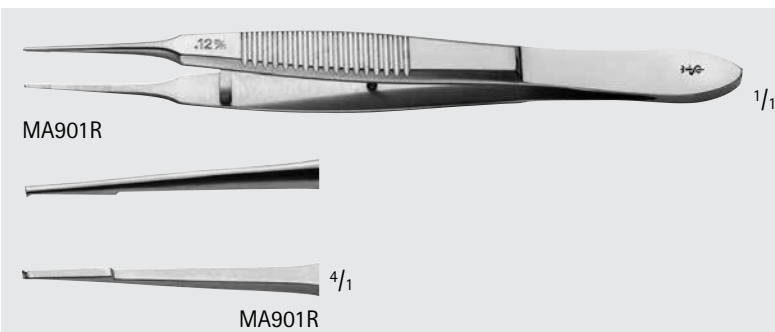

THORPE Corneal Forceps W/ Platform

Catalog Number	Tip Size (mm)	Jaw	Teeth	Length (in.)
MA901R	0.12	STR	2 x 3, ANG 45°	3 3/4

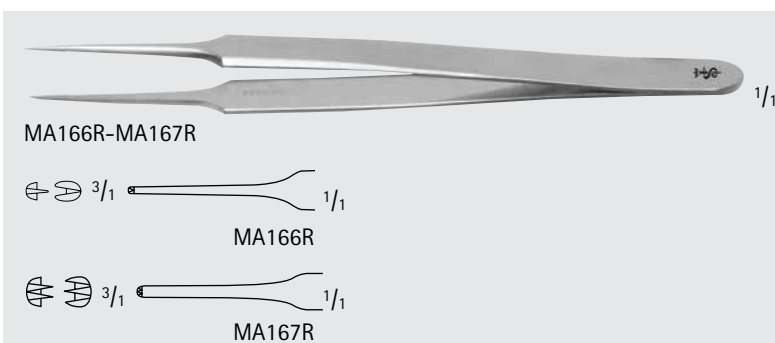

LESTER Fixation Forceps

Catalog Number	Teeth	Length (in.)
MA166R	FINE, 1 x 2	3 3/4
MA167R	FINE, 2 x 3	3 3/4

Eye Forceps



MA170R-MA171R

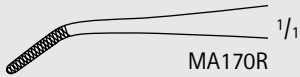

MA170R

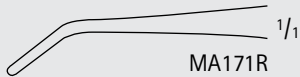

MA171R

NUGENT Utility Forceps

Catalog Number	Jaw	Jaw Length (mm)	Length (in.)
MA170R	SERR, ANG 45°	10	4 1/4
MA171R	SMOOTH, ANG 45°	10	4 1/4



MA902R

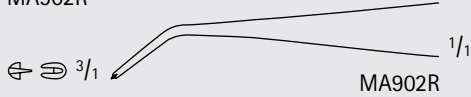

MA902R

TROUTMAN Superior Rectus Forceps

Catalog Number	Tip Size (mm)	Jaw	Teeth	Length (in.)
MA902R	10	ANG	1 x 2	4 1/8



MA316R-MA317R



MA316R-MA317R

BERKE Ptosis Forceps, W/ Lock

Catalog Number	Jaw Length (mm)	Length (in.)
MA316R	20	4
MA317R	27	4 1/8



MA548R

Serrefine Clamp

Catalog Number	Tip	Jaw	Jaw Length (mm)	Length (in.)
MA548R	STR	SERR	10	1 3/8

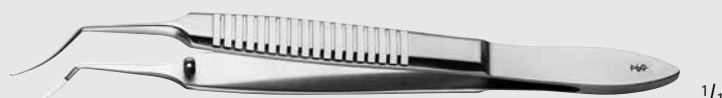

MA881R

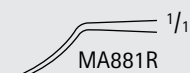

MA881R



4/1

LEHNER-UTRATA Capsulotomy Forceps

Catalog Number	Tip	Tip Size (mm)	Length (in.)
MA881R	ANG	12	3 1/2

EYE



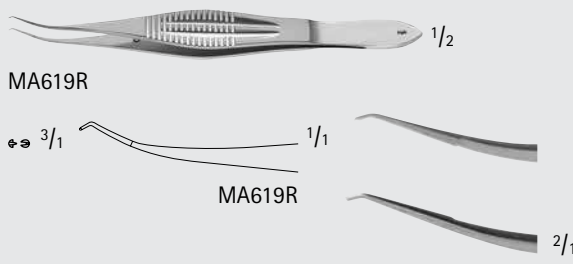

UTRATA Capsulorhexis Forceps

Catalog Number	Tip	Tip Size (mm)	Handle	Length (in.)
MA617R	ANG	12	FLAT, SERR	3 1/8
MG363R	ANG	11	FLAT, FENESTRATED	4

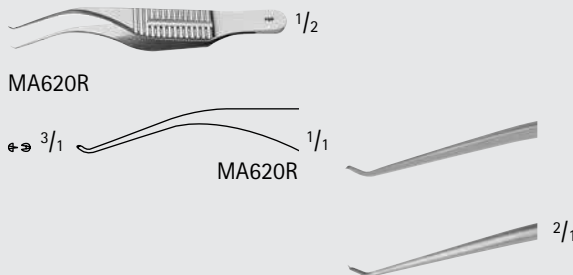

COLIBRI-Style Corneal Forceps, W/ Platform

Catalog Number	Tip	Tip Size (mm)	Teeth	Length (in.)
MA619R	ANG 50°	6	1 x 2	4 1/4



TROUTMAN-BARRAQUER Corneal Forceps

Catalog Number	Tip Size (mm)	Teeth	Length (in.)
MA620R	0.12	1 x 2	2 7/8

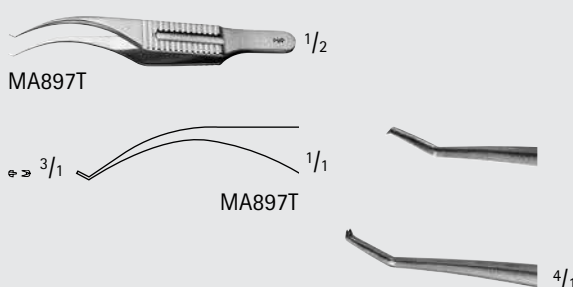

Titanium COLIBRI Forceps

Catalog Number	Tip Size (mm)	Jaw	Teeth	Length (in.)
MA897T	0.12	SMOOTH	1 x 2	3

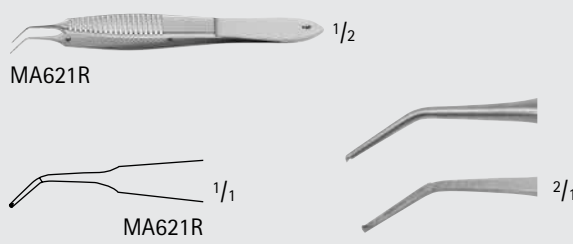

MCPHERSON Angled Corneal Suturing Forceps, W/ Platform

Catalog Number	Tip	Tip Size (mm)	Teeth	Length (in.)
MA621R	ANG 45°	5	1 x 2	3 3/8

Eye Forceps

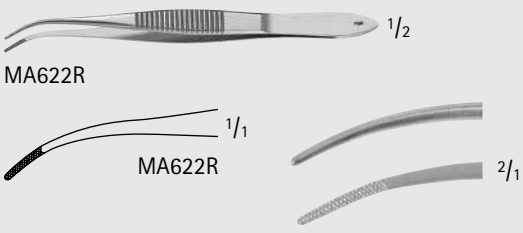
BRACKEN Iris Forceps

Catalog Number	Tip	Jaw	Length (in.)
MA622R	CVD	CROSS-SERR	3 7/8

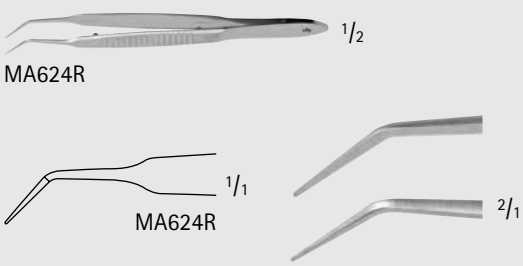

KELMAN-MCPHERSON Forceps, W/ Platform

Catalog Number	Tip	Tip Size (mm)	Length (in.)
MA624R	ANG 45°	8.5	3 3/8

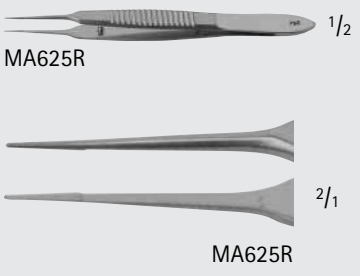

MCPHERSON Forceps, W/ Platform

Catalog Number	Tip	Tip Size (mm)	Length (in.)
MA625R	STR	5	3 1/4

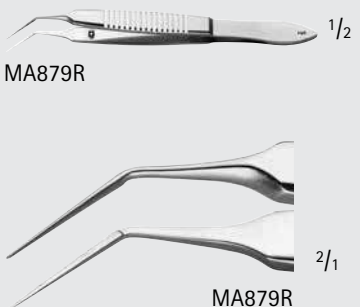

BECHERT-MCPHERSON Forceps

Catalog Number	Tip	Tip Size (mm)	Jaw	Length (in.)
MA879R	ANG	10	SMOOTH	3 1/4

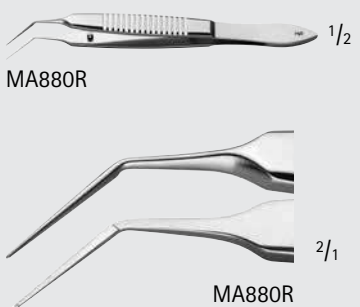

SHEETS-MCPHERSON Forceps

Catalog Number	Tip	Tip Size (mm)	Jaw	Length (in.)
MA880R	1 MM X-SERR	10	ANG	3 1/4



MA626R



MA626R



MA726R



MA726R

JAMESON Muscle Forceps, W/ Lock

Catalog Number	Tip Size (mm)	Jaw	Length (in.)
MA626R	12	ANG, LEFT	3 3/8
MA726R	12	ANG, RIGHT	4



MA623R

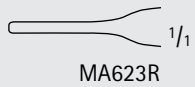

MA623R

MCCULLOUGH Utility Forceps

Catalog Number	Tip	Tip Size (mm)	Jaw	Length (in.)
MA623R	STR	15	SMOOTH	3 5/8



MA899R



MA899R

Tying Forceps

Catalog Number	Jaw	Handle	Length (in.)
MA899R	SMOOTH	FLAT, SERR	4 1/4



MA900R



MA900R

Alabama University Forceps, W/ Platform

Catalog Number	Tip	Tip Size (mm)	Length (in.)
MA900R	V-GROOVED	15	3 1/2

Eye Forceps



MA882R

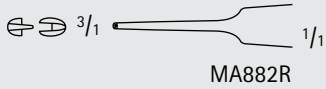

MA882R

Von GRAEFE Iris Forceps

Catalog Number	Tip	Teeth	Length (in.)
MA882R	STR	1 x 2	3

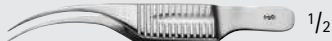

MA883R

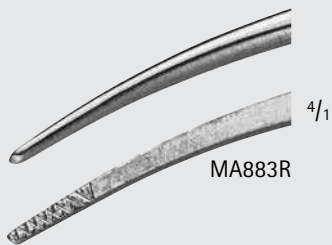

MA883R

GILL Iris Forceps

Catalog Number	Tip	Jaw	Length (in.)
MA883R	CVD	CROSS-SERR	3



MA877R

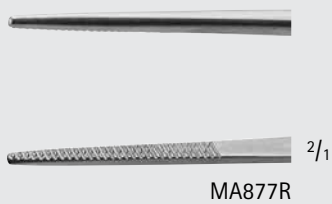

MA877R

WILLS Hospital Utility Forceps

Catalog Number	Tip	Jaw	Length (in.)
MA877R	STR	SERR	4

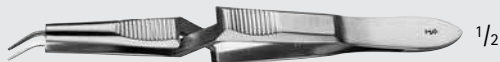

MA884R



MA884R

WATZKE Sleeve Spreading Forceps

Catalog Number	Tip	Jaw Length (mm)	Length (in.)
MA884R	ANG	10	4 3/4



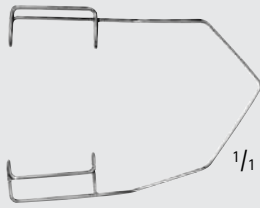

OA200R

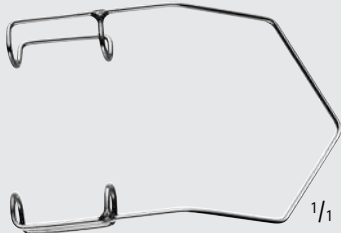

MA752R

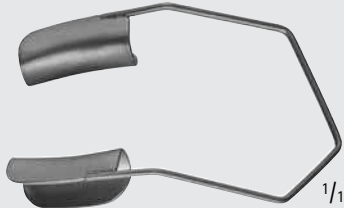

MA754R



MA751R

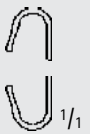

BARRAQUER Eye Speculum

Catalog Number	Blade Size (mm)	Frame	Length (in.)
MA751R	10	WIRE	1 1/2
OA200R	10	WIRE	1 3/4
MA752R	14	HEAVY WIRE	1 3/4
MA754R	15	SOLID	1 3/4

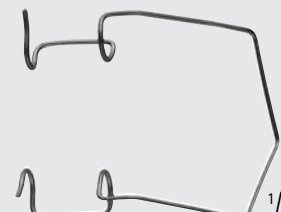

MA756R

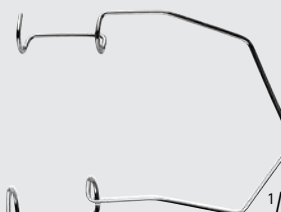

MA755R

KRATZ-BARRAQUER Eye Speculum

Catalog Number	Blade Size (mm)	Blade Shape	Length (in.)
MA756R	10	PEDIATRIC	1 3/8
MA755R	14	ADULT	1 1/2



INCHES

Eye Specula



MA757R

ALPHONSO Speculum, Infant

Catalog Number	Blade Size (mm)	Length (in.)
MA757R	7 x 5 AND 9 WIDE	1 3/4



MA750R

LIEBERMAN Speculum, Adjustable

Catalog Number	Blade Size (mm)	Blade Shape	Length (in.)
MA750R	16	STR, SQUARE WIRE	3 1/8
MA758R	14	ANG, SQUARE WIRE	3 1/4
MA759R	14	ANG, V-SHAPE WIRE	3 1/4
MA760R	14	ANG, SOLID	3 1/4
MA764R	14	ANG, REVERSIBLE, SOLID	3 1/8



MA758R



MA759R



MA760R



MA764R



MA763R

JAFFE Wire Lid Retractor, Pair

Catalog Number	Blade Size (mm)	Length (in.)
MA763R	13	1 1/2
MA762R	15	1 1/2



MA762R

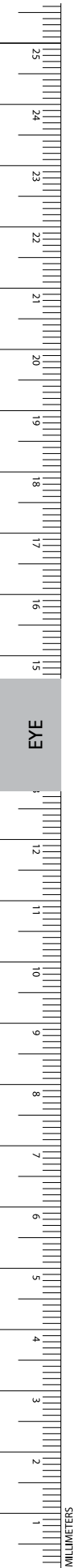



OA218R



OA218R

SAUER Eye Speculum

Catalog Number	Length (in.)
OA218R	1 3/8



MA638R



MA638R

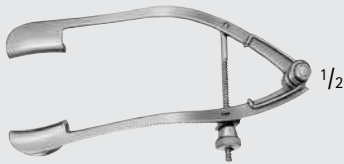

OA225R



OA225R

LANCASTER Eye Speculum

Catalog Number	Length (in.)
MA638R	2 3/4
OA225R	3 1/8



BV013R



BV013R

LOGAN Modified REILL Self-Retaining Retractor

Catalog Number	Length (in.)
BV013R	2



INCHES

Eye

Hooks and Retractors



MA434R-MA437R

SEWALL Orbital Retractor

Catalog Number	Blade Size (mm)	Length (in.)
MA434R	7 x 52	6 3/4
MA435R	9 x 44	6 3/8
MA436R	11 x 50	6 3/8
MA437R	13 x 67	6 3/4

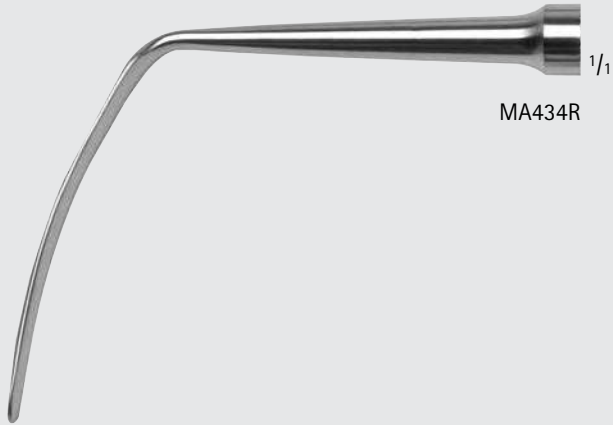

MA434R



MA435R



MA436R



MA437R



OA310R-OA314R

DESMARRES Lid Retractor

Catalog Number	Blade Size (mm)	Length (in.)
OA310R	9 x 9	5 1/2
OA311R	9 x 12	5 1/2
OA312R	11 x 14	5 1/2
OA313R	12 x 16	5 1/2
OA314R	13 x 18	5 1/2

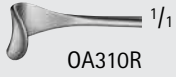

OA310R



OA311R

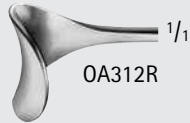

OA312R



OA313R



OA314R



MA749R

SCHEPENS Orbital Retractor

Catalog Number	Tip	Blade Size (mm)	Length (in.)
MA749R	SMOOTH	14 x 61	6 1/8



MA765

JAEGER Lid Plate, Clear Plastic

Catalog Number	Blade Size (mm)	Length (in.)
MA765	20/23	3 3/4



EYE

INCHES

Eye

Hooks / Retractors / Manipulators



MA766R

BERKE-JAEGER Lid Plate

Catalog Number	Blade Size (mm)	Length (in.)
MA766R	20/30	4 1/4



MA731R

WELLS Enucleation Spoon

Catalog Number	Diameter (mm)	Length (in.)
MA731R	21	5 3/4



MA744R-MA745R



MA744R



MA745R

BUNGE Evisceration Spoon

Catalog Number	Tip	Diameter (mm)	Length (in.)
MA744R	SMALL	8	5 1/4
MA745R	LARGE	12	5 1/2



MA761R

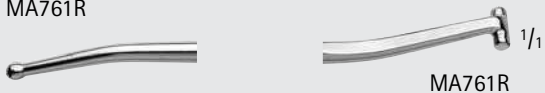

MA761R

SCHOCKET Scleral Depressor, Double Ended

Catalog Number	Length (in.)
MA761R	5 1/4



MA747R



MA747R

FLYNN Scleral Depressor

Catalog Number	Diameter (mm)	Length (in.)
MA747R	5	3 1/8



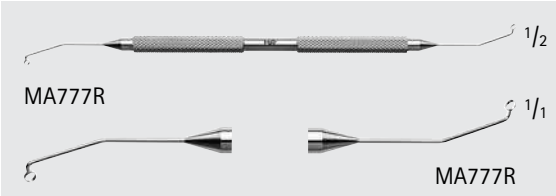
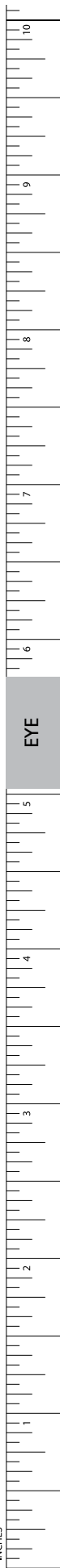

WHITMAN-SHEPHERD Capsule Polisher, Double Ended

Catalog Number	Tip	Length (in.)
MA777R	LEFT ANG, RIGHT ANG	5 1/8

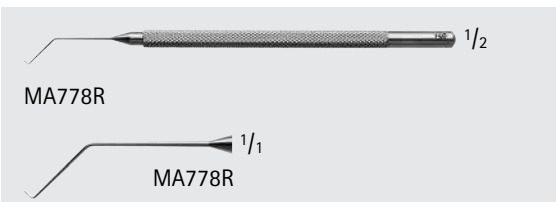

KOCH Stop and Chop Manipulator, Angled Shaft

Catalog Number	Tip Size (mm)	Length (in.)
MA778R	1.5	4 3/4



CAMELLIN Style LASIK Alcohol Well

Catalog Number	Diameter (mm)	Length (in.)
MA779R	8.5	4 1/2

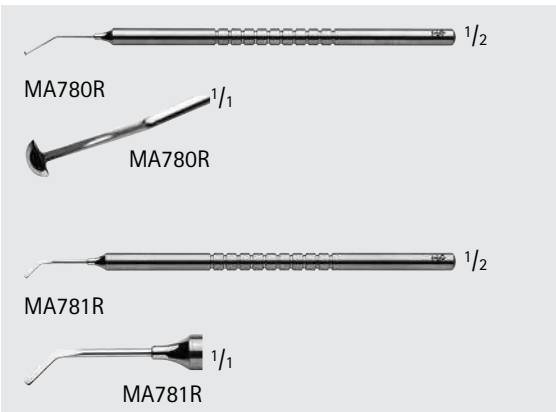

SLOANE LASIK Spatula

Catalog Number	Tip	Description	Length (in.)
MA780R	SEMI-CIRCULAR, BEVELED EDGE	MICRO HOE	4 1/2
MA781R	SEMI-SHARP	EPI PEELER	4 1/2

Eye

Hooks / Retractors / Manipulators

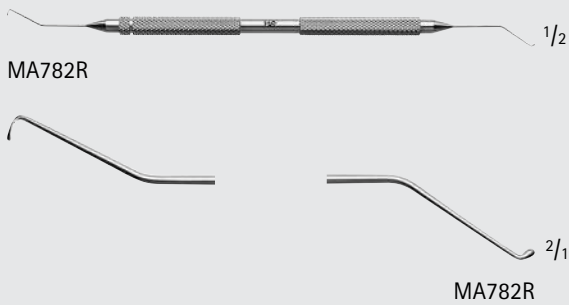

CHANG-SEIBEL Phaco Chopper, Double Ended

Catalog Number	Tip	Style	Length (in.)
MA782R	ANG C-SHAPED BLUNT CHOPPER / VERTICAL SAFETY CHOPPER	F/ LEFT HAND	5 1/2

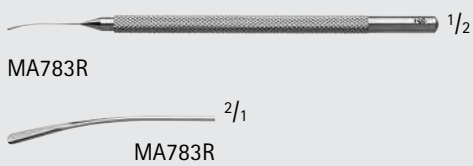

KOCH Nucleus Spatula

Catalog Number	Tip	Tip Size (mm)	Length (in.)
MA783R	SLIGHTLY CVD W/ DUCKBILL TIP	1	4 1/2

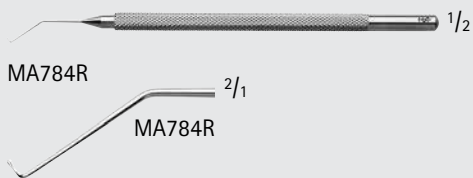

LIEBERMAN Nucleus Manipulator

Catalog Number	Style	Shaft	Length (in.)
MA784R	F/ LEFT HAND	ANG	4 1/2

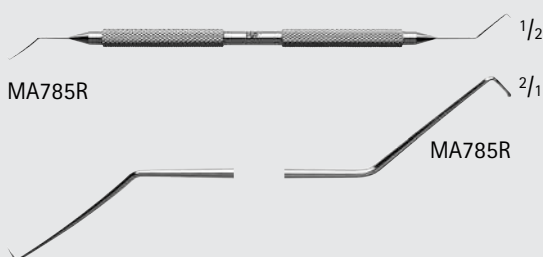

CHANG Combo Phaco Chopper, Double Ended

Catalog Number	Tip	Style	Shaft	Length (in.)
MA785R	C-SHAPED BLUNT CHOPPER / 1.3 MM SHARP QUICK CHOP TIP	F/ LEFT HAND	ANG	5 1/4

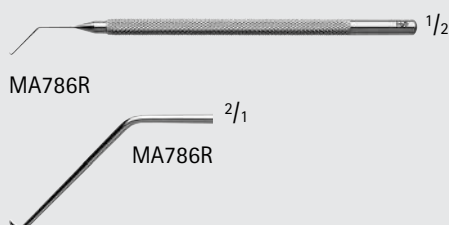

NAGAHARA Nucleus Spatula

Catalog Number	Tip	Style	Shaft	Length (in.)
MA786R	FLAT INTERIOR EDGE	F/ LEFT HAND	ANG	4 1/4

EYE

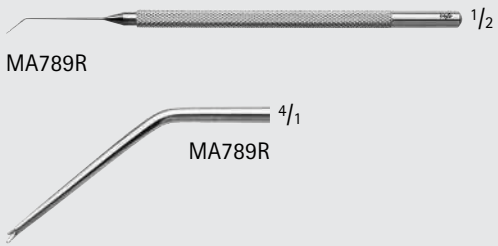

BECHERT Nucleus Rotator

Catalog Number	Tip	Shaft	Length (in.)
MA789R	Y-SHAPED	ANG 45° 7 MM FROM TIP	4 3/4

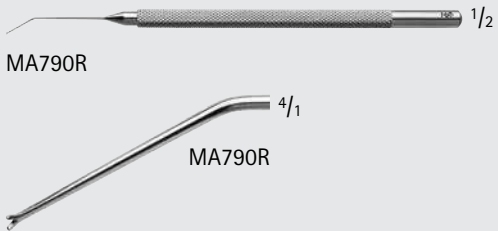

JAFFE-BECHERT Nucleus Rotator

Catalog Number	Tip	Shaft	Length (in.)
MA790R	Y-SHAPED	ANG 45° 9 MM FROM TIP	4 3/4

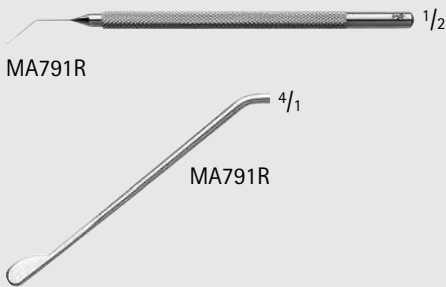

DRYSDALE Nucleus Manipulator

Catalog Number	Tip	Length (in.)
MA791R	PADDLE-SHAPED	4 1/4

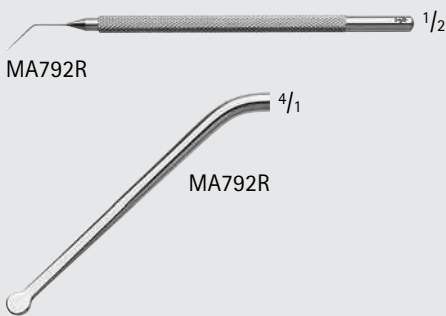

PISACANO Nucleus Rotator

Catalog Number	Tip	Length (in.)
MA792R	VERTICAL FLAT	4 1/4

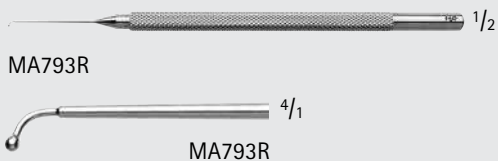

ANIS-WAND Nucleus Manipulator

Catalog Number	Tip	Tip Size (mm)	Shaft	Length (in.)
MA793R	BALL-SHAPED	0.5	STR	4 3/4



Eye

Hooks / Retractors / Manipulators

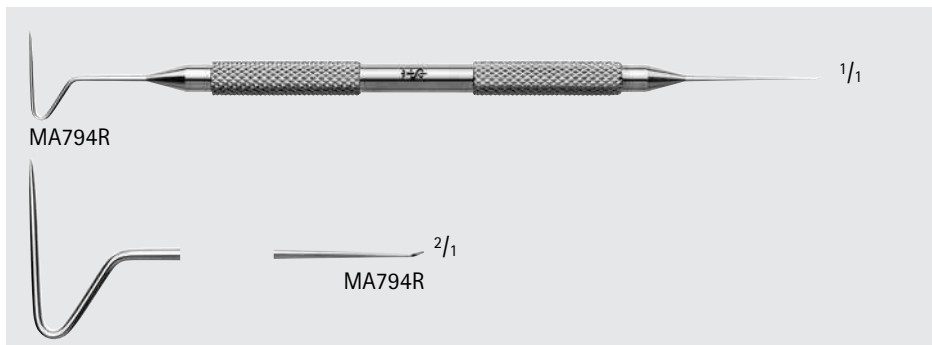

SIEBEL Flap Lifter and Spatula, Double Ended

Catalog Number	Tip	Length (in.)
MA794R	Z-SHAPED AND 1.5 MM ANG POINT	4 1/8

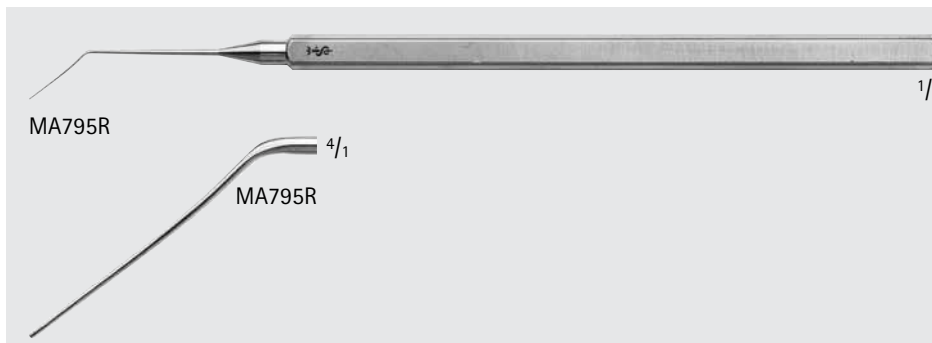

JAFFE Lens Spatula

Catalog Number	Tip	Tip Size (mm)	Length (in.)
MA795R	FLAT	0.5	4 3/4

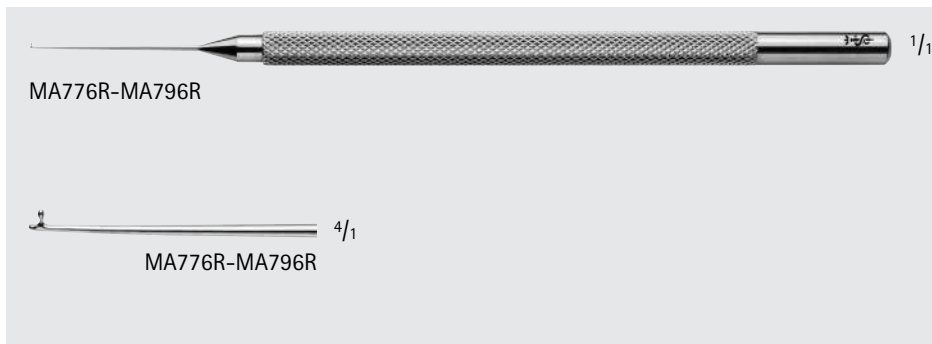

LESTER IOL Manipulator

Catalog Number	Tip	Tip Size (mm)	Shaft	Length (in.)
MA776R	TEARDROP-SHAPED	0.25	STR	4 1/2
MA796R	TEARDROP-SHAPED	0.25	ANG	4 1/2

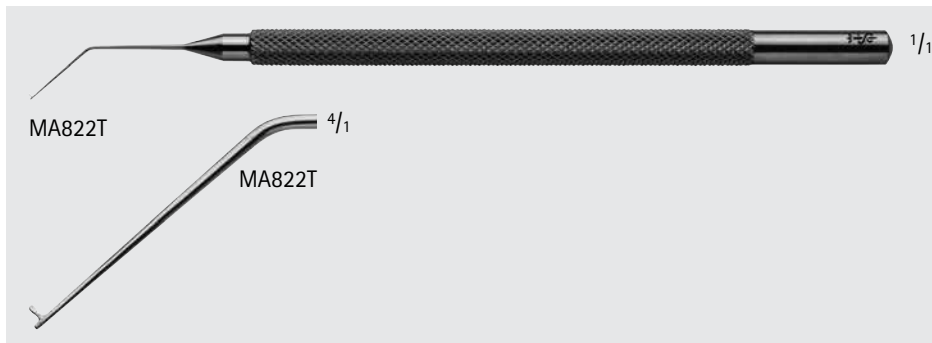

LESTER II Titanium IOL Manipulator

Catalog Number	Tip	Tip Size (mm)	Shaft	Length (in.)
MA822T	TEARDROP-SHAPED	0.20	ANG	4 1/2



MALONEY IOL Manipulator

Catalog Number	Tip	Tip Size (mm)	Shaft	Length (in.)
MA797R	TEARDROP-SHAPED	0.25	CVD	4 1/2



MA637R

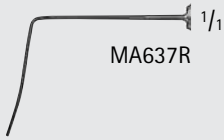

MA637R

BARRAQUER Cyclodialysis Spatula

Catalog Number	Blade Size (mm)	Blade	Length (in.)
MA637R	0.5 x 15	ANG	4 7/8

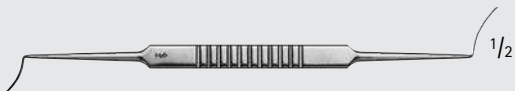

MA799R



MA799R

CASTROVIEJO Cyclodialysis Spatula, Double Ended

Catalog Number	Blade Size (mm)	Length (in.)
MA799R	0.5 x 10 / 0.5 x 15	5 1/8



MA798R

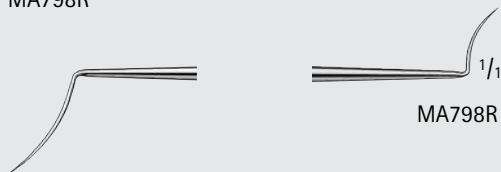

MA798R

CASTROVIEJO Synechia Spatula, Double Ended

Catalog Number	Blade Size (mm)	Length (in.)
MA798R	0.5	5 1/4

MA798R



MA823R



MA823R

NEW ORLEANS Lens Loop

Catalog Number	Tip	Length (in.)
MA823R	4 x 10	5 1/2



MA801R

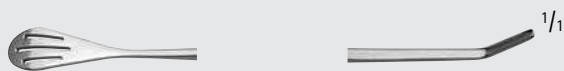

MA801R

PATON Spatula and Spoon, Double Ended

Catalog Number	Tip	Length (in.)
MA801R	6 MM WIDE GROOVED SPOON / 1.5 MM FLAT BLADE ANG AT 8 MM	5 1/2



INCHES

Eye

Hooks / Retractors / Manipulators



MA803R

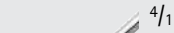

MA803R

GRAETHER Collar Button

Catalog Number	Tip	Shaft	Length (in.)
MA803R	0.6 MM BUTTON	ANG 45° 10 MM FROM TIP	4 3/4



MA805R

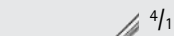

MA805R

CLAYMAN-JAFFE Lens Hook

Catalog Number	Tip	Tip Size (mm)	Shaft	Length (in.)
MA805R	ANG 90° BLUNT	0.15	ANG 45° 10 MM FROM TIP	4 1/2



MA806R

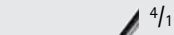

MA806R

HARRS-SINSKEY Lens Manipulating Hook

Catalog Number	Tip	Tip Size (mm)	Shaft	Handle	Length (in.)
MA806R	BLUNT	0.25	ANG 45° 10 MM FROM TIP	FLAT	4 1/2

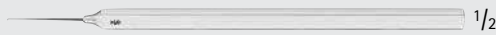

MA630R



MA630R



MA824R

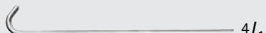

MA824R



MA804R

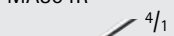

MA804R



MA807R



MA807R



MA808R

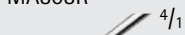

MA808R

SINSKEY Lens Manipulating Hook

Catalog Number	Tip	Tip Size (mm)	Shaft	Handle	Length (in.)
MA630R	BLUNT	0.25	STR	FLAT	4 5/8
MA824R	BLUNT	0.20	MODIFIED CVD	FLAT	4 1/2
MA804R	BLUNT, REVERSE	0.20	ANG	FLAT	4 1/2
MA807R	BLUNT	0.25	STR	ROUND	4 1/2
MA808R	BLUNT	0.25	ANG	ROUND	4 1/2

EYE

SINSKEY II Lens Manipulating Hook

Catalog Number	Tip	Tip Size (mm)	Shaft	Handle	Length (in.)
MA809R	BLUNT	0.2	STR	FLAT	4 1/2
MA810R	BLUNT	0.2	ANG	FLAT	4 1/2
MA811R	BLUNT	0.2	STR	ROUND	4 1/2
MA812R	BLUNT	0.2	ANG	ROUND	4 1/2

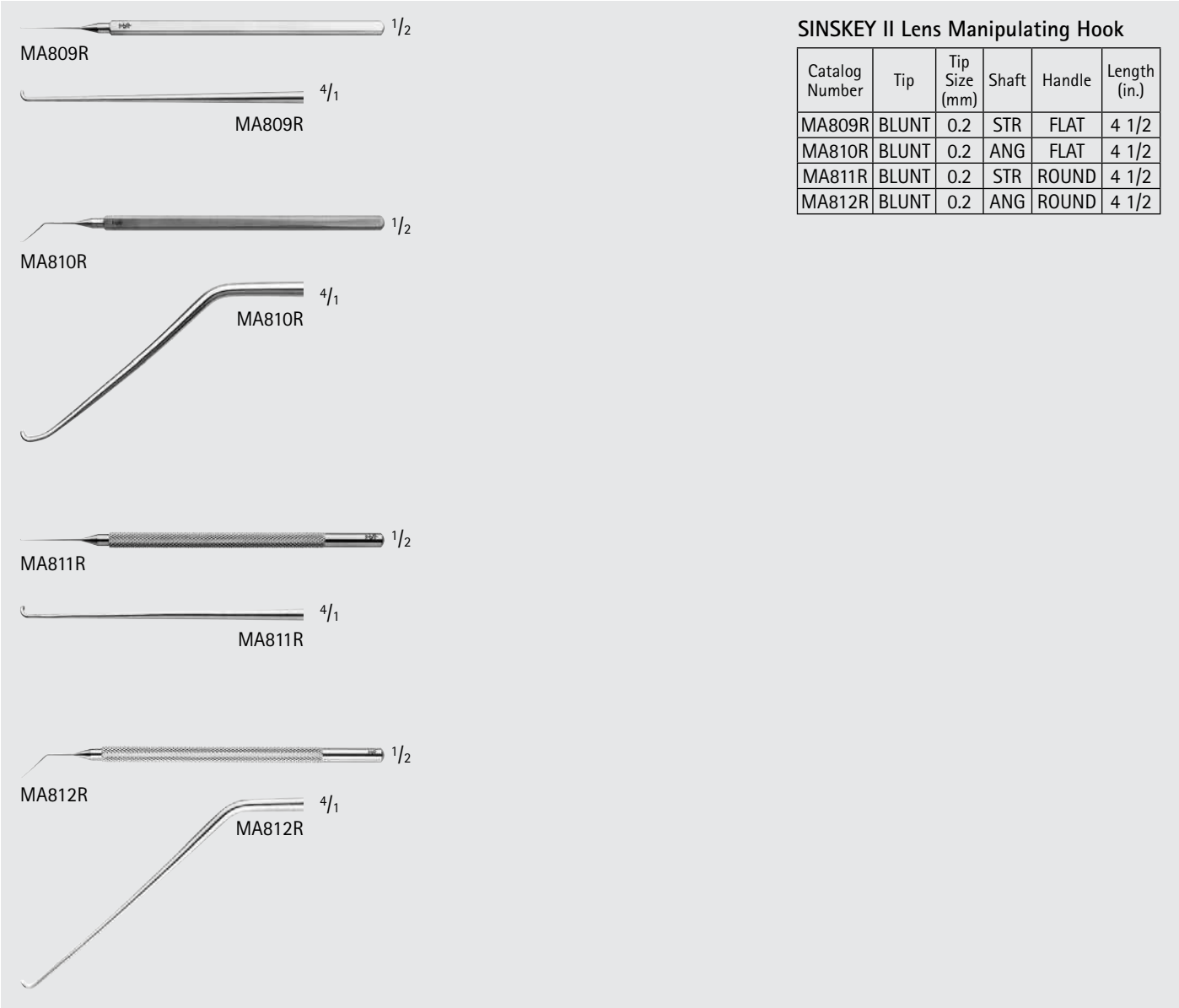

SINSKEY II Titanium Lens Manipulating Hook

Catalog Number	Tip	Tip Size (mm)	Shaft	Handle	Length (in.)
MA825T	BLUNT	0.2	STR	FLAT	4 1/2
MA819T	BLUNT	0.2	ANG	ROUND	4 1/2

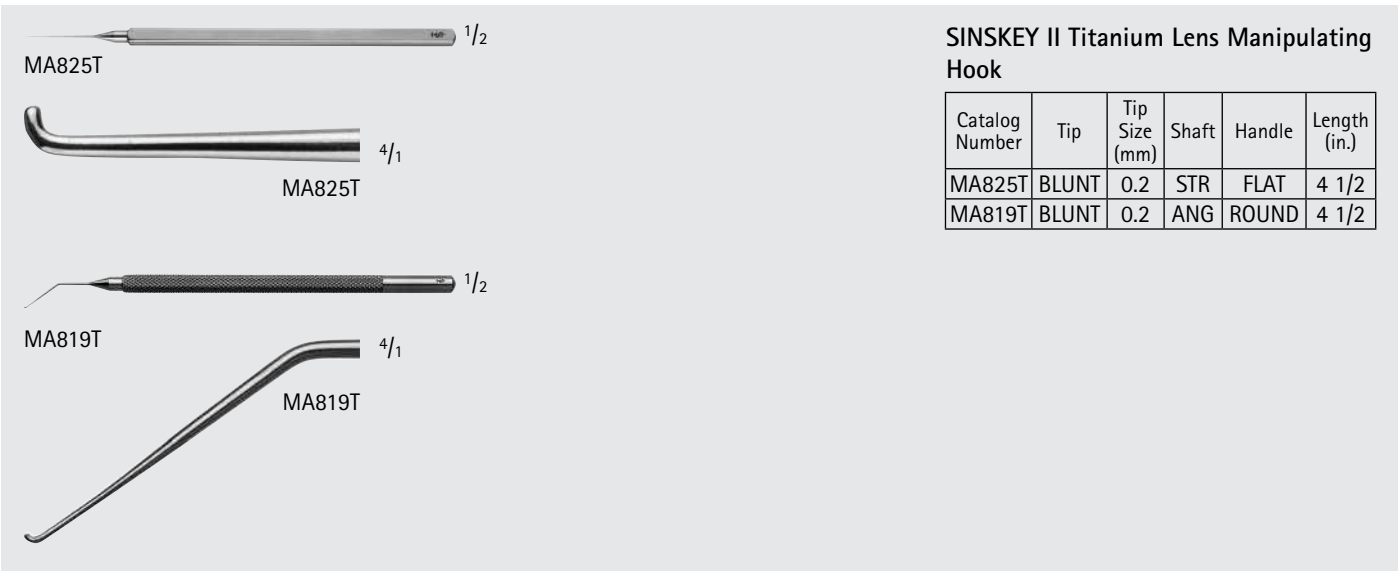

Eye

Hooks / Retractors / Manipulators

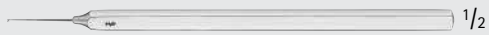

MA631R



MA631R



MA813R-MA814R



MA813R

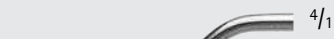

MA814R



MA815R-MA816R



MA815R

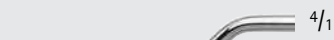

MA816R

KUGLEN Iris Hook and Lens Manipulator

Catalog Number	Tip	Tip Size (mm)	Shaft	Handle	Length (in.)
MA631R	K-HOOK	0.5	STR	SQUARE	4 5/8
MA813R	PUSH-PULL	-	STR	FLAT	4 1/2
MA814R	PUSH-PULL	-	ANG	FLAT	4 1/2
MA815R	PUSH-PULL	-	STR	ROUND	4 1/2
MA816R	PUSH-PULL	-	ANG	ROUND	4 1/2



MA827T



MA827T



MA826T

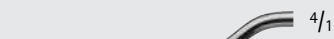

MA826T

KUGLEN Titanium Iris Hook and Lens Manipulator

Catalog Number	Tip	Shaft	Handle	Length (in.)
MA827T	K-HOOK	STR	ROUND	4 1/2
MA826T	PUSH-PULL	ANG	ROUND	4 1/2

EYE

MILLIMETERS

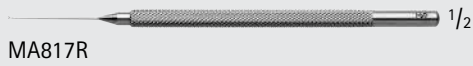

OSHER "Y"-Hook Lens Manipulator

Catalog Number	Tip	Shaft	Length (in.)
MA817R	Y-SHAPED	STR	4 1/2

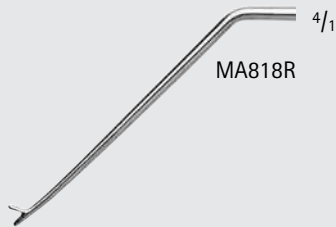
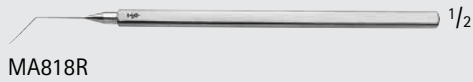

JAFFE-MALTZMAN Lens Manipulating Hook

Catalog Number	Tip	Tip Size (mm)	Shaft	Length (in.)
MA818R	V-SHAPED	0.15	ANG	4 1/2



MCPHERSON Iris Spatula

Catalog Number	Blade Size (mm)	Length (in.)
MA775R	1 x 16	4 1/2

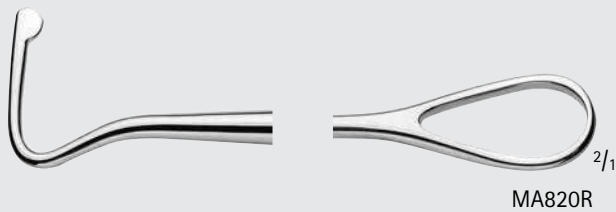

KIRBY Hook and Muscle Loop, Double Ended

Catalog Number	Blade Size (mm)	Length (in.)
MA820R	5 x 10	6 1/8



BONN Micro Iris Hook

Catalog Number	Tip	Shaft	Length (in.)
MA821R	BLUNT	STR	5



Eye

Hooks / Retractors / Manipulators



MA632R



MA632R



MA828R



MA828R

JAMESON Muscle Hook

Catalog Number	Size	Tip Size (mm)	Length (in.)
MA632R	SMALL	9	5 1/4
MA828R	LARGE	10	5 1/4



MA633R



MA633R

GREEN Strabismus Hook

Catalog Number	Tip	Tip Size (mm)	Length (in.)
MA633R	FLAT	8	5 1/8



MA634R

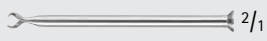

MA634R

Twist Fixation Hook

Catalog Number	Tip	Length (in.)
MA634R	RIGHT, CLOCKWISE TWIST	4 1/4



MA635R



MA635R

GASS Retinal Detachment Hook

Catalog Number	Length (in.)
MA635R	5 5/8



MA636R

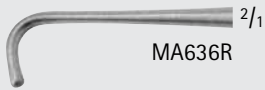

MA636R

STEVENS Tenotomy Hook

Catalog Number	Tip	Tip Size (mm)	Length (in.)
MA636R	CVD, BLUNT	5	4 5/8



MA800R



MA800R

ALFONSO Nucleus Trisector

Catalog Number	Tip Size (mm)	Length (in.)
MA800R	1.5	4 3/4



MA194R

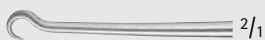

MA194R

TYRELL Iris Hook

Catalog Number	Tip	Tip Size (mm)	Length (in.)
MA194R	SHARP	2	4 3/4



EYE

INCHES

Eye

Fixation Rings and Markers



MA732R-MA742R

FLIERINGA Scleral Fixation Ring

Catalog Number	Diameter (mm)	Description
MA743R	12-22	SET OF 8 RINGS
MA732R	12	-
MA733R	13	-
MA734R	14	-
MA735R	15	-
MA736R	16	-
MA737R	17	-
MA738R	18	-
MA739R	19	-
MA740R	20	-
MA741R	21	-
MA742R	22	-



MA975R



MA975R

OSHER-NEUMANN Corneal Marker

Catalog Number	Tip	Length (in.)
MA975R	8 BLADES	4 1/8



MA829R



MA829R

THORNTON Swivel Fixation Ring

Catalog Number	Tip	Diameter (mm)	Length (in.)
MA829R	BLUNT TEETH	13	4 1/2

EYE

MILLIMETERS

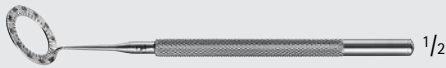

MA833R



MA833R

MENDEZ Degree Gauge, Calibrated 10° from 0-180°

Catalog Number	Inner Diameter (mm)	Compatible w/	Length (in.)
MA833R	12	MA836R	4 1/4



MA836R



MA836R

BORES Axis Marker

Catalog Number	Compatible w/	Length (in.)
MA836R	MA833R	4



MA834R



MA834R

HENDERSON Degree Gauge

Catalog Number	Tip	Compatible w/	Length (in.)
MA834R	BEVELED FACE, SMOOTH	MA837R	4 1/8

For use with MA837R



MA835R



MA835R

HENDERSON Alignment Marker

Catalog Number	Tip	Compatible w/	Length (in.)
MA835R	BLUNT PIN MARKINGS AT 3, 6 AND 9 O'CLOCK	MA834R AND MA837R	4

For use with MA837R



MA837R



MA837R

HENDERSON Toric IOL Marker

Catalog Number	Tip	Compatible w/	Length (in.)
MA837R	2.5 MM AXIS MARKS	MA834R	4

Eye

Fixation Rings and Markers



MA838R-MA841R



MA838R



MA839R



MA840R



MA841R

BORES Optical Zone Marker

Catalog Number	Inner Diameter (mm)	Length (in.)
MA838R	3.5	4
MA839R	6	4 1/8
MA840R	7	4 1/8
MA841R	8	4 1/8



MA842R-MA846R



MA842R



MA843R



MA844R

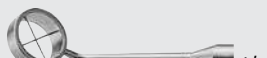

MA845R

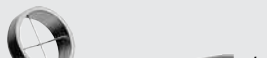

MA846R

HOFFER Optical Zone Marker

Catalog Number	Inner Diameter (mm)	Length (in.)
MA842R	4.25	4
MA843R	5	4
MA844R	5.5	4
MA845R	6	4
MA846R	8	4 1/8

EYE

MILLIMETERS

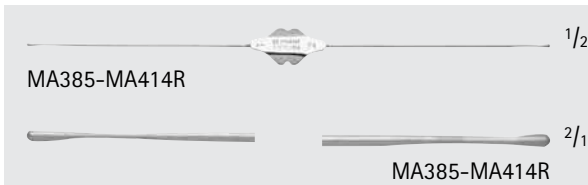

WILLIAMS Lacrimal Probe, Double Ended

Catalog Number	Tip Size (#)	Length (in.)
MA385	0000/000	5 1/8
MA410R	00/0	5 1/2
MA411R	1/2	5 1/2
MA412R	3/4	5 1/2
MA413R	5/6	5 1/2
MA414R	7/8	5 1/2

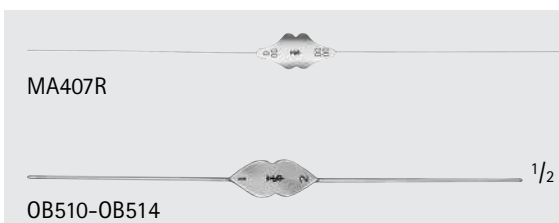

BOWMAN Lacrimal Probe, Double Ended

Catalog Number	Tip Size (#)	Tip Size (mm)	Description	Length (in.)
MA409	-	-	SET OF 6	-
MA407R	0000/000	-	-	5 5/8
OB510	00/0	0.7 / 0.8	-	5 1/8
OB511	1/2	0.9 / 1.1	-	5 1/8
OB512	3/4	1.3 / 1.4	-	5 1/8
OB513	5/6	1.5 / 1.6	-	5 1/8
OB514	7/8	1.8 / 1.9	-	5 1/8

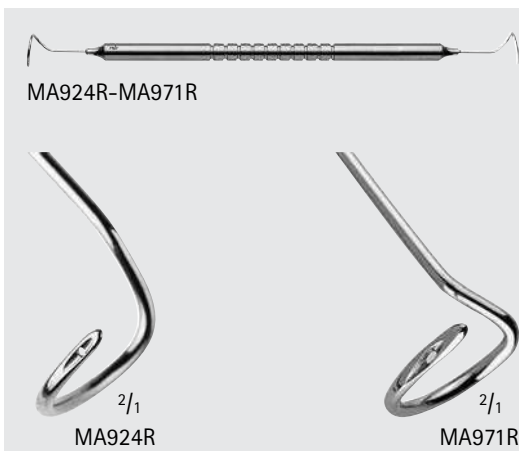

Pigtail Lacrimal Probe, Double Ended, W/ Suture Holes

Catalog Number	Tip	Diameter (mm)	Length (in.)
MA924R	BLUNT	8	5 1/8
MA971R	BLUNT	8	6 1/8

Eye

Probes and Dilators

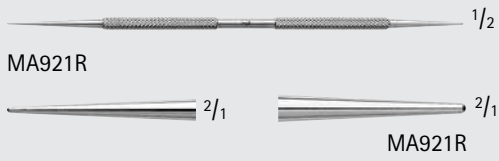

CASTROVIEJO Lacrimal Dilator, Double Ended

Catalog Number	Tip	Length (in.)
MA921R	FINE TAPPER/ MEDIUM TAPER	4 3/4

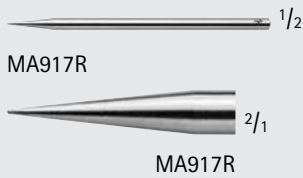

RUEDEMANN Lacrimal Dilator

Catalog Number	Tip	Length (in.)
MA917R	12 MM TAPER	2 3/4

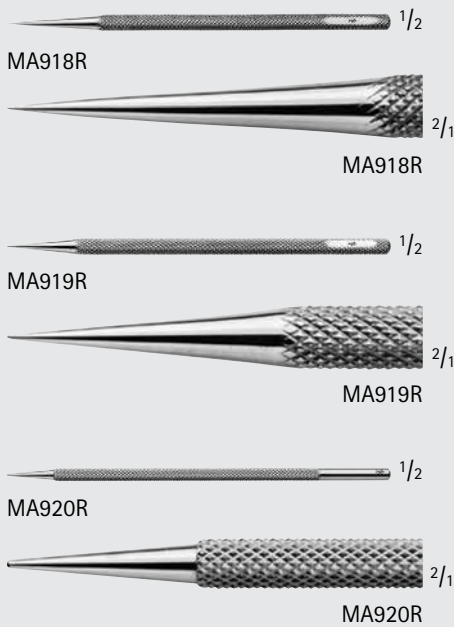

WILDER Lacrimal Dilator

Catalog Number	Tip	Tip Size (mm)	Size	Length (in.)
MA918R	LONG TAPER	23	1	4
MA919R	MEDIUM TAPER	18	2	4
MA920R	SHORT TAPER	13	3	4

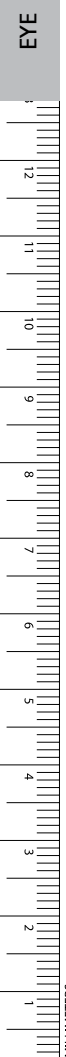

**CATALANO Lacrimal Intubation Set,
Single Use**

Catalog Number	Description
MA915R	TWO 0.7 MM PROBES ATTACHED TO 250 MM LONG SILICONE TUBING

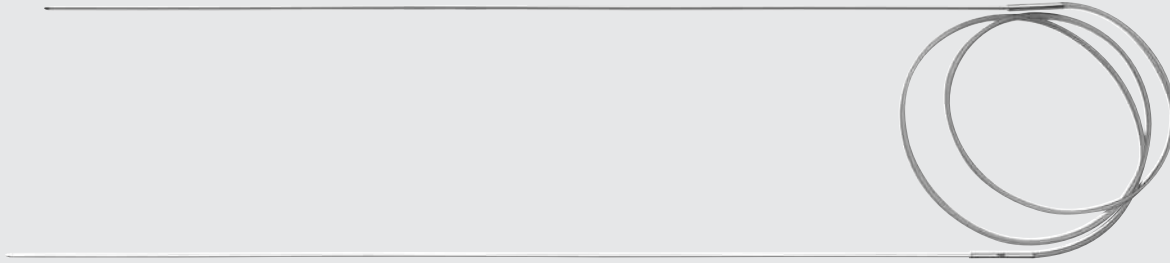

MA915R

**JACKSON Lacrimal Intubation Set,
Single Use**

Catalog Number	Description
MA916R	TWO 0.9 MM PROBES ATTACHED TO 250 MM LONG SILICONE TUBING

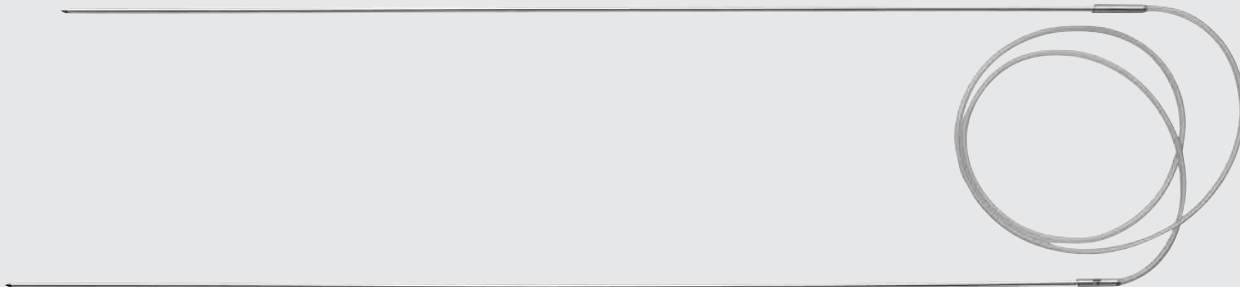

MA916R



EYE

INCHES

Eye

Lacrimal Intubation Sets



CRAWFORD Lacrimal Intubation Set, Single Use

Catalog Number	Description
MA922R	TWO OLIVE-TIPPED 0.8 MM PROBES ATTACHED TO 250 MM LONG SILICONE TUBING



MA922R

CRAWFORD Retrieving Hook

Catalog Number	Compatible w/	Length (in.)
MA923R	MA922R	5 1/8

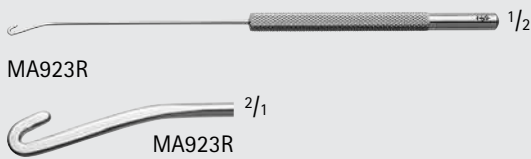

MA923R

MA923R

2/1

1/2



Lacrimal Cannula

Catalog Number	Tip	Tip Size (Gauge)	Shaft	Length (in.)
MA925R	REINFORCED, MALLEABLE	23	STR	1 3/8
MA926R	REINFORCED, MALLEABLE	23	CVD	1 3/8
MA959R	-	23	STR	1

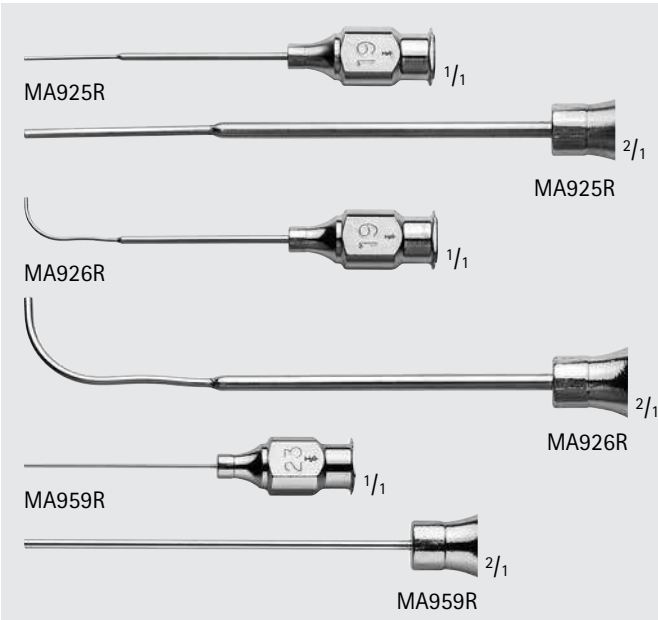

SHAHINIAN Lacrimal Cannula

Catalog Number	Tip	Tip Size (Gauge)	Shaft	Length (in.)
MA927R	0.3 MM SIDE PORT	23	STR	3/8

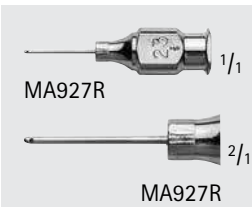

RANDOLPH Cyclodialysis Cannula

Catalog Number	Tip	Tip Size (Gauge)	Shaft	Length (in.)
MA930R	THIN	19	ANG 13 MM FROM TIP	1 3/8
MA970R	DEL	19	ANG 13 MM FROM TIP	1 1/4

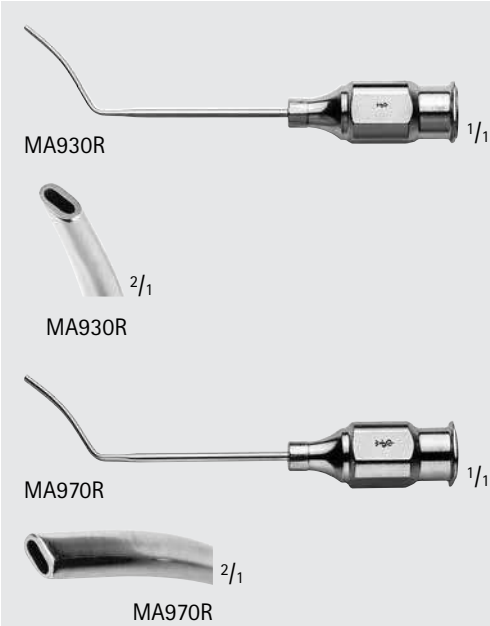

TROUTMAN Olive Tip Cannula

Catalog Number	Tip	Tip Size (Gauge)	Shaft	Length (in.)
MA931R	1	25	SLIGHT-CVD	1

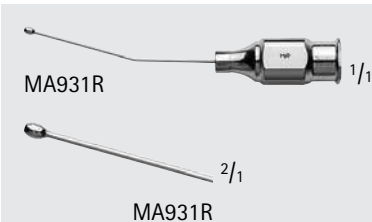

Eye Cannulas

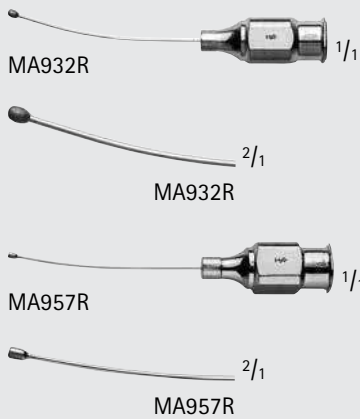

JENSEN Capsule Polisher, Roughened Tip, W/ Front Opening

Catalog Number	Tip	Tip Size (Gauge)	Shaft	Length (in.)
MA932R	OLIVE	25	CVD	1
MA957R	OLIVE	27	CVD	1

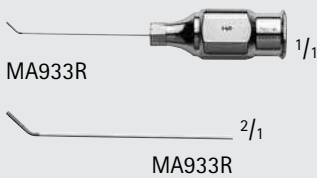

KNOLLE Capsule Polisher, Roughened Tip

Catalog Number	Tip	Tip Size (Gauge)	Length (in.)
MA933R	2 MM ANG	30	3/4



BISHOP-HARMON Anterior Chamber Irrigator, 19 GA, Angled

Catalog Number	Description	Length (in.)
MA934R	COMPLETE SET	-
MA935	SILICONE BULB, 28 x 55 MM	-
MA936	PLASTIC ADAPTER, F/ USE W/ MA935	-
MA937R	CANNULA	1

MA934R Includes:

1 Cannula MA937R

1 Plastic Adaptor MA936

1 Silicone Bulb MA935

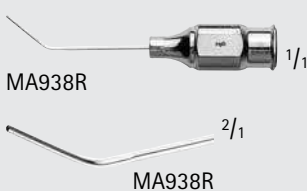

Hydrodissection Cannula

Catalog Number	Tip	Tip Size (Gauge)	Shaft	Length (in.)
MA938R	FLATTENED, FRONT OPENING	25	ANG	3/4





BRACKEN Irrigating Cannula

Catalog Number	Tip	Tip Size (Gauge)	Shaft	Length (in.)
MA939R	FLATTENED BEVELED, FRONT OPENING	19	CVD	1 1/4



SLADE LASIK Cannula

Catalog Number	Tip	Tip Size (Gauge)	Shaft	Length (in.)
MA940R	FLATTENED SPATULA, FRONT OPENING	26	ANG	1/2

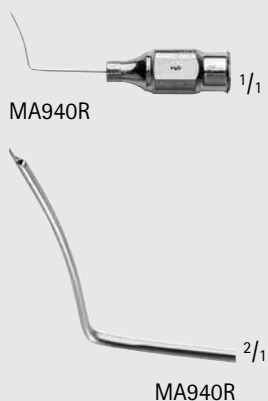

BURATTO Cannula

Catalog Number	Tip	Tip Size (Gauge)	Shaft	Length (in.)
MA941R	FLATTENED, 1 FRONT AND 2 SIDE PORTS	25	ANG	1

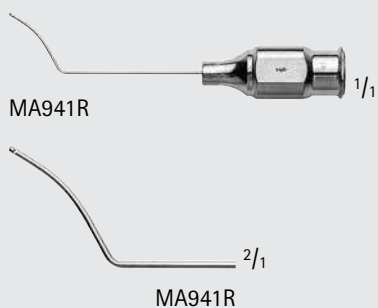

Eye Cannulas

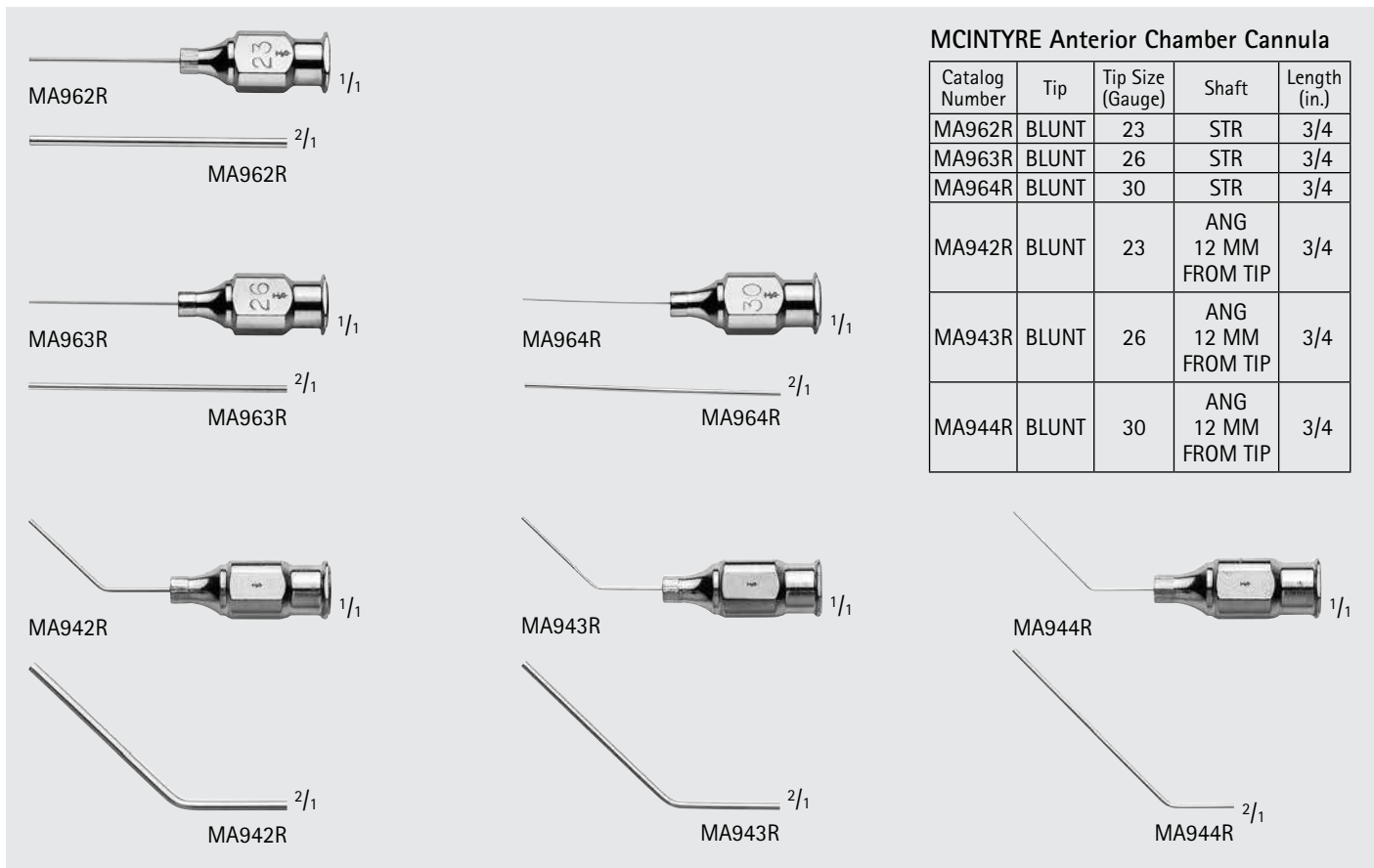

MCINTYRE Anterior Chamber Cannula

Catalog Number	Tip	Tip Size (Gauge)	Shaft	Length (in.)
MA962R	BLUNT	23	STR	3/4
MA963R	BLUNT	26	STR	3/4
MA964R	BLUNT	30	STR	3/4
MA942R	BLUNT	23	ANG 12 MM FROM TIP	3/4
MA943R	BLUNT	26	ANG 12 MM FROM TIP	3/4
MA944R	BLUNT	30	ANG 12 MM FROM TIP	3/4

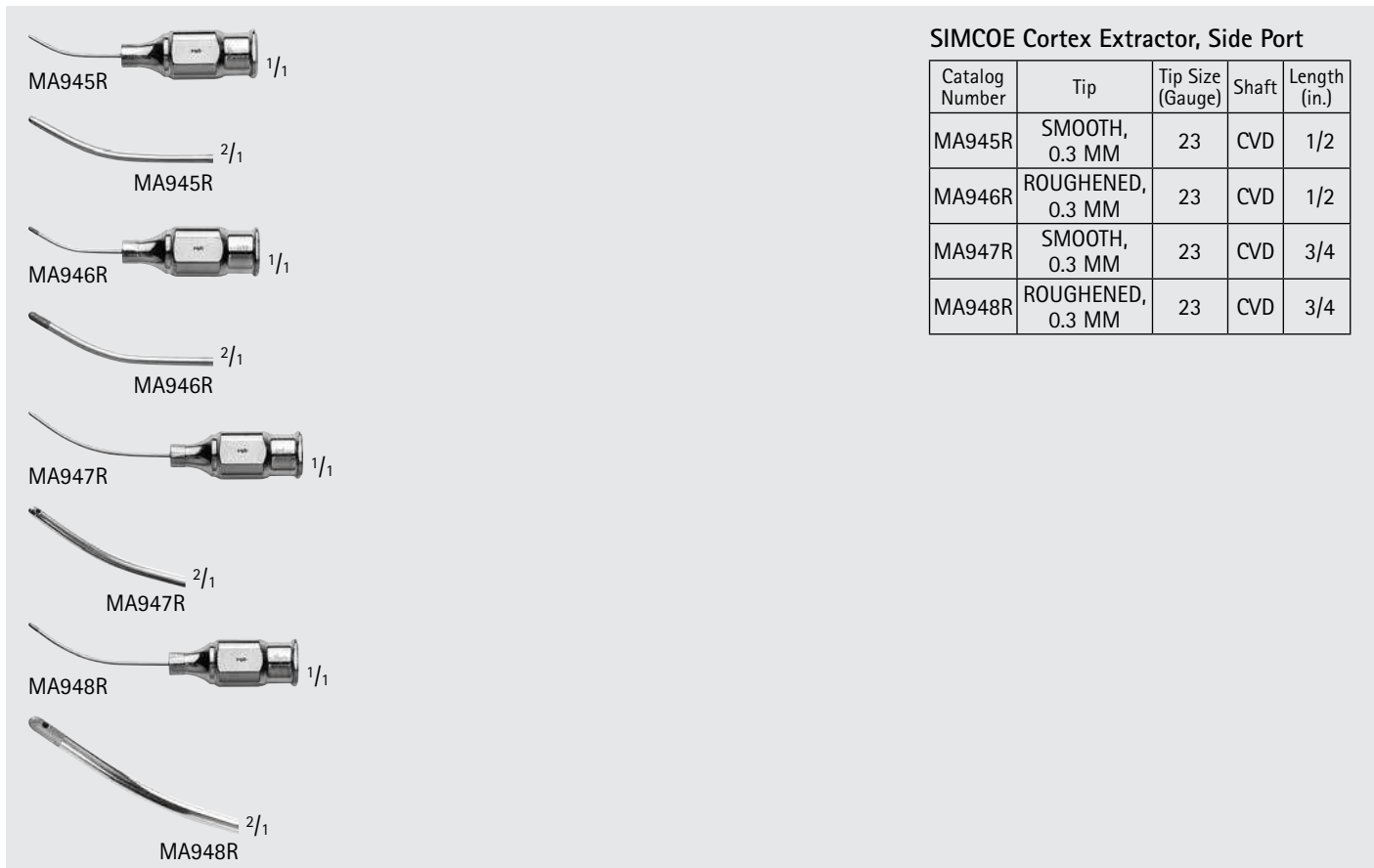

SIMCOE Cortex Extractor, Side Port

Catalog Number	Tip	Tip Size (Gauge)	Shaft	Length (in.)
MA945R	SMOOTH, 0.3 MM	23	CVD	1/2
MA946R	ROUGHENED, 0.3 MM	23	CVD	1/2
MA947R	SMOOTH, 0.3 MM	23	CVD	3/4
MA948R	ROUGHENED, 0.3 MM	23	CVD	3/4

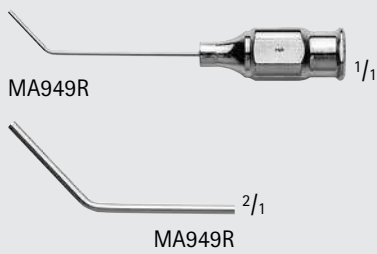
MORRISON Aspirating Cannula, Front Opening

Catalog Number	Tip	Tip Size (Gauge)	Shaft	Length (in.)
MA949R	SMOOTH, BLUNT	23	ANG 7 MM FROM TIP	1

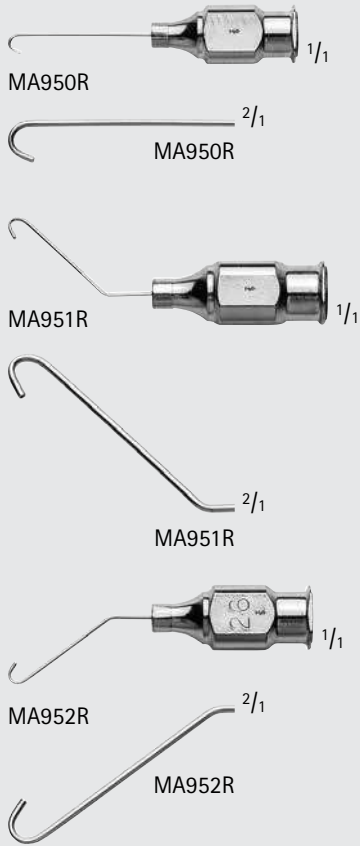

MCINTYRE-BINKHORST Cannula, Front Opening, Hook Shape

Catalog Number	Tip	Tip Size (Gauge)	Shaft	Length (in.)
MA950R	SMOOTH, BLUNT	26	STR	3/4
MA951R	SMOOTH, BLUNT	26	RIGHT ANG	3/4
MA952R	SMOOTH, BLUNT	26	LEFT ANG	3/4

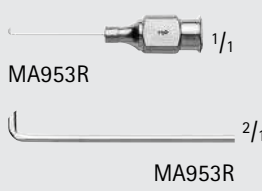

CHANG Nucleus Hydrodissector Cannula

Catalog Number	Tip	Tip Size (Gauge)	Shaft	Length (in.)
MA953R	FLAT, BEVELED OPENING	27	RIGHT ANG	1/2

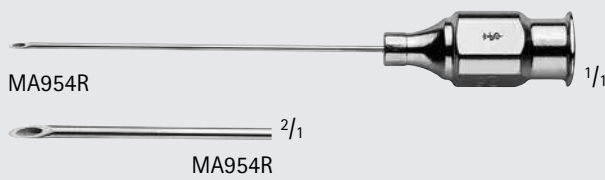

ATKINSON Retrobulbar Needle

Catalog Number	Tip Size (Gauge)	Shaft	Length (in.)
MA954R	23	STR	1 3/8

Eye Cannulas

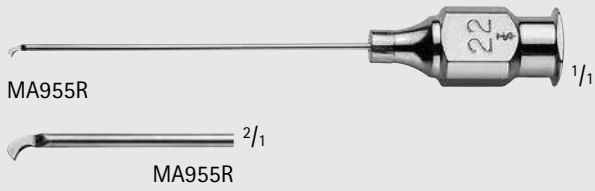

KELMAN Cystotome

Catalog Number	Tip Size (Gauge)	Shaft	Length (in.)
MA955R	22	STR	1 1/4

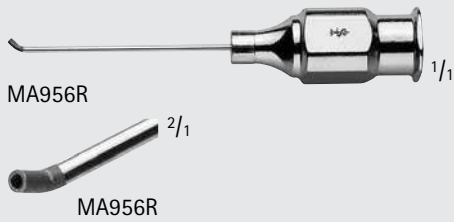

KRATZ Capsule Scrubber

Catalog Number	Tip	Tip Size (Gauge)	Shaft	Length (in.)
MA956R	ROUGHENED	23	ANG	3/4

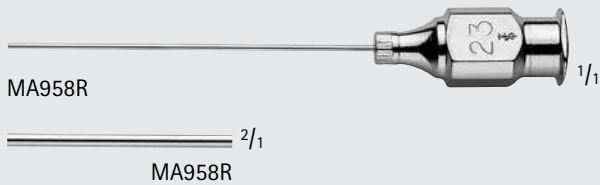

Backflush Infusion Cannula

Catalog Number	Tip Size (Gauge)	Shaft	Length (in.)
MA958R	23	STR	1 3/8

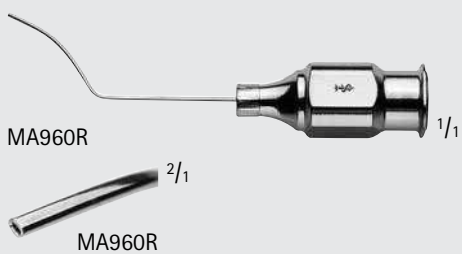

NICHAMIN Hydrodissection Cannula

Catalog Number	Tip Size (Gauge)	Shaft	Length (in.)
MA960R	25	ANG	1

EYE



Air Injection Cannula

Catalog Number	Tip Size (mm)	Tip Size (Gauge)	Shaft	Length (in.)
MA640R	5	27	ANG	3/4
MA641R	5	30	ANG	3/4

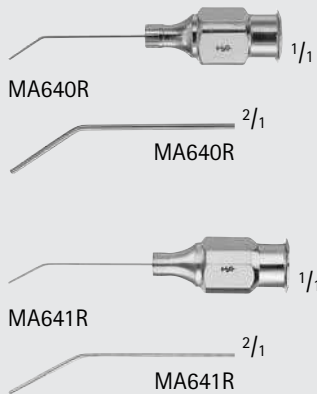

WEST Lacrimal Cannula, Side Port

Catalog Number	Tip Size (mm)	Tip Size (Gauge)	Shaft	Length (in.)
MA968R	0.3	23	STR	1 1/4

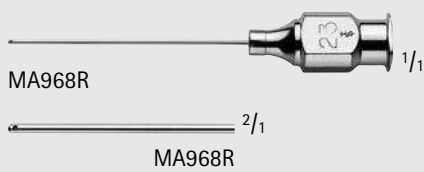

SIMCOE Irrigating Aspirating Unit

Catalog Number	Tip Size (Gauge)	Description
MA965R	23	ASPIRATION THROUGH 0.3 MM TOP PORT, IRRIGATION THROUGH FRONT PORT, USES 225 MM TUBING

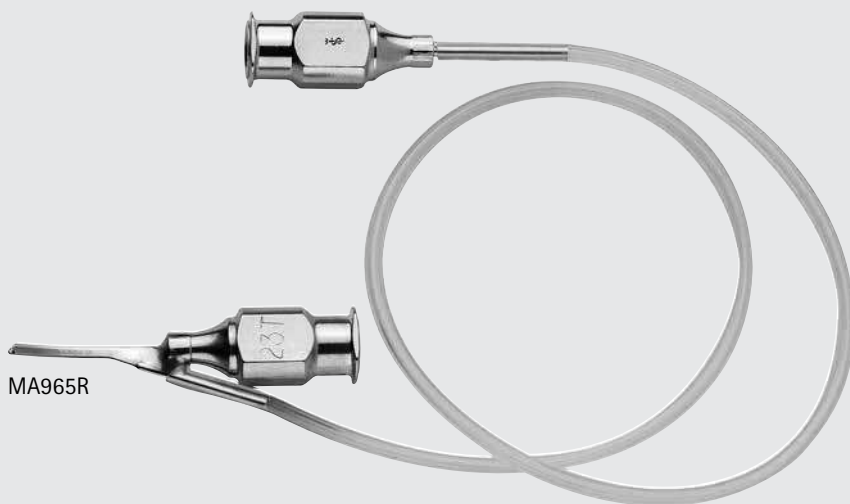

Eye

Miscellaneous



MA002R



MA001R

BRAUNSTEIN Fixed Caliper, Double Ended

Catalog Number	Tip Size (mm)	Length (in.)
MA002R	3.0 / 3.5	2 3/4
MA001R	3.5 / 4.0	2 3/4



MB791R



OB793R

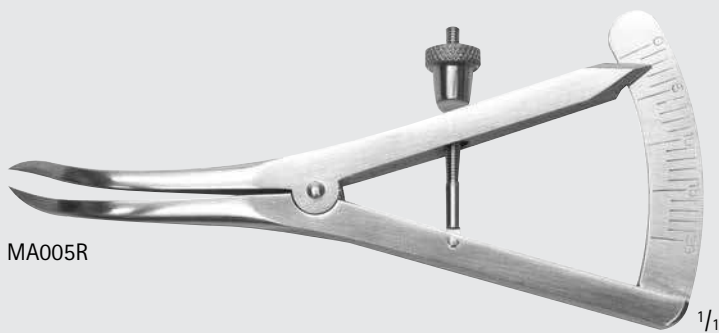

MA005R

CASTROVIEJO Eye Caliper

Catalog Number	Tip	Description	Length (in.)
MB791R	STR	0 - 15 MM RANGE	3 1/8
OB793R	STR	0 - 40 MM RANGE	6 3/4
MA005R	CVD	0 - 20 MM RANGE	3 3/8



MA888R



MA888R

AKAHOSHI Combo Prechopper, Cross-Action

Catalog Number	Jaw	Jaw Length (mm)	Length (in.)
MA888R	STR	4.5	4 1/4

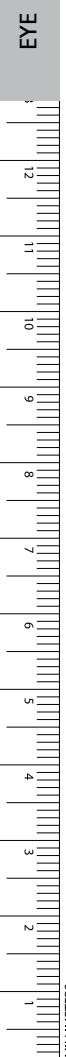

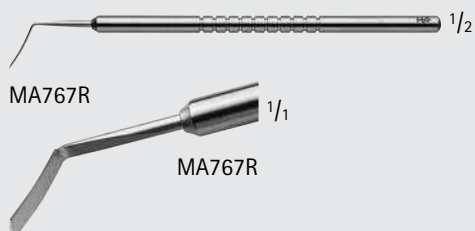

Corneal Dissector Knife

Catalog Number	Blade	Shaft	Length (in.)
MA767R	CVD	ANG	4 1/2

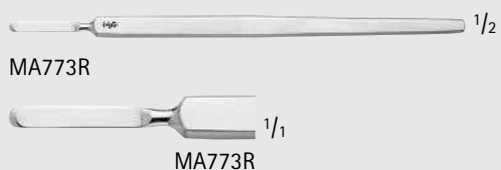

TOOKE Corneal Knife

Catalog Number	Blade	Blade Size (mm)	Length (in.)
MA773R	STR	3 x 18	4 3/4

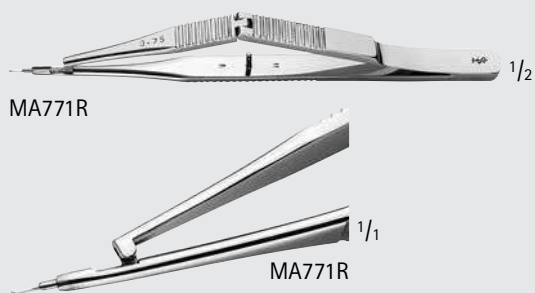

KELLY-DESCEMET'S Membrane Punch

Catalog Number	Diameter (mm)	Length (in.)
MA771R	1	5 1/8

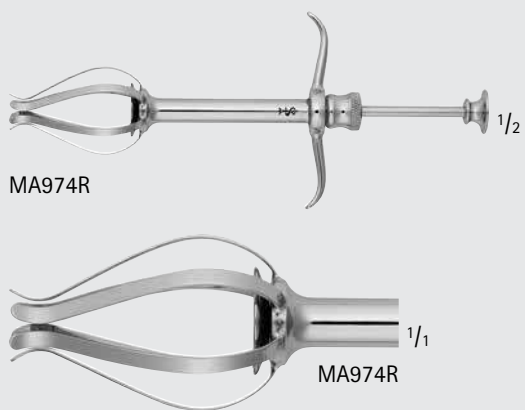

CARTER Sphere Introducer

Catalog Number	Length (in.)
MA974R	5

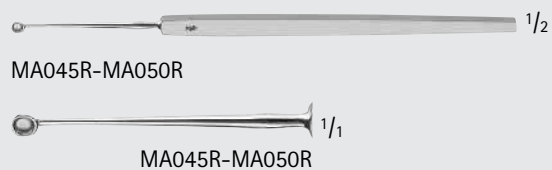

MEYERHOEFFER Chalazion Curette

Catalog Number	Tip Size (#)	Cup (mm)	Length (in.)
MA045R	0	1.5	5
MA046R	1	1.7	5
MA047R	2	2	5
MA049R	3	2.5	5
MA050R	4	3.5	5



INCHES

ROYAL

INTERNATIONAL



ALIS



Manufacturing Unit -

***115-A Waryana Industrial Complex, Leather Complex Road,
Jalandhar Punjab, 144021***



Sales Office -

***Plot No. 581- Kakrola Housing Complex, Near Metro Pillar 802,
Dwarka Mor, Delhi, 110078***



Our Certifications -

***UDYAM , ISO 13485, WHO-GMP, ISO 9001:2015, CE , ROHS,
FDA , MD-42, MD-5***

CONTACT US:



+91- 98141-81255, +91- 98142-62255



www.alisprofessional.com



info@royalinternational.org